



MULTIPLE GEAR PUMPS



POMPE MULTIPLE AD INGRANAGGI MULTIPLE GEAR PUMPS



PRESENTAZIONE DESCRIPTION	B-2
CARATTERISTICHE TECNICHE TECHNICAL FEATURES	B-2
GAMMA DI PRODOTTO PRODUCT RANGE	B-3
DESIGNAZIONE DESIGNATION	B-4
GR1 + GR1	B-6
GR1 + GR1 TC	B-8
GR1 + GR1 + GR1 TC	B-10
GR2 + GR1	B-11
GR2 + GR1 TC	B-14
GR2 + GR2	B-16
GR2 + GR2 TC	B-18
GR3 + GR1	B-20
GR3 + GR1 TC	B-22
GR3 + GR2	B-24
GR3 + GR2 TC	B-26
GR3 + GR3	B-28
GR3 + GR3 TC	B-29
GR4 + GR1	B-30
GR4 + GR2	B-30
GR4 + GR3	B-30
GR4 + GR4	B-30



PRESENTAZIONE

Le pompe in Tandem (o pompe multiple) sono disponibili in esecuzione STANDARD e T.C. (Tandem corto) e possono essere a due o più stadi.

La versatilità delle nostre pompe consente il montaggio di una pompa multipla utilizzando pompe singole ed effettuando solo operazioni di disassemblaggio/assemblaggio di estrema semplicità.

- Tutte le pompe Galtech sono già predisposte per il traino di una successiva pompa.
- Una quantità molto limitata di kit "flangia di collegamento e accessori" permette di mantenere un basso valore nel magazzino e soprattutto di dare un servizio rapido agli utilizzatori finali.

DESCRIPTION

The multiple pumps are available in STANDARD and T.C. (short-tandem) versions.

The versatility of our pumps permits the assembling of a multiple pump using a single pump and making only a simply operation of disassembly/assembly.

- All our standard pumps are already present to engage another pump.
- A very limited quantity of kit "flange connections and accessories" gives a small stock value and mainly a rapid assistance to final users.

CARATTERISTICHE TECNICHE

- Le prestazioni delle unità che compongono la pompa multipla sono identiche a quelle delle singole pompe corrispondenti.
- La coppia massima di rotazione della pompa multipla è determinata dalla pompa con velocità minore.
- La coppia massima assorbita da ogni singola unità, tale da consentire il limite di funzionamento alla pressione massima di impiego, si calcola come segue:

$$M = \frac{c \times p}{64}$$

dove:

- M = Coppia massima assorbita (Nm)
- c = Cilindrata pompa (cm³/giro)
- p = Pressione massima di impiego (bar)

- La somma delle coppie assorbite dalle singole pompe non deve essere superiore alla coppia massima ammissibile sull'albero principale (vedi tabella).

La coppia massima assorbita dalle pompe seguenti non deve essere superiore alla coppia trasmissibile dal tramo della pompa precedente.

- La potenza assorbita dalla pompa multipla è data dalla somma delle potenze assorbite dalle singole pompe, si calcola come segue:

$$P = \frac{c \times n \times p}{603000}$$

dove:

- P = Potenza massima assorbita (Kw)
- c = cilindrata pompa (cm³/giro)
- n = Numero di gin massimo (giri/min)
- p = Pressione massima di impiego (bar)

TECHNICAL FEATURES

- Performance of units composing multiple pumps are the same as these of the corresponding single pumps.

- Max. rotation speed of multiple pumps is given by slower pump.

- Max. torque absorbed by each simple unit to grant a working limit at max. working pressure is calculated in the following way:

$$M = \frac{c \times p}{64}$$

in which:

- M = Max absorbed input torque (ft.lbs)
- c = Pump displacement (cm³/rev)
- p = Max. working pressure (bar)

- The total of the torque absorbed by each pump shall be not in excess of the max. allowed torque on main shaft (see below scheme)

The max. torque absorbed by the follow pumps shall be not in excess of the torque transmitted by the rear draft gear.

- The power absorbed by the multiple pump is determined from total powers that each pump absorbed and it is calculated as follow:

$$P = \frac{c \times n \times p}{603000}$$

in which:

- P = Max. absorbed power (Kw)
- c = Pump displacement (cm³/rev)
- n = Max. rev working (rpm)
- p = Max. working pressure (bar)

	Coppia trasmessa dall'albero principale Torque transmitted by the draft pump [Nm] (ft.lbs)								Coppia trasmessa dal traino pompa Torque transmitted by rear draft [Nm] (ft.lbs)
	Tipo 10 Type 10	Tipo 11 Type 11	Tipo 12 Type 12	Tipo 13 Type 13	Tipo 14 Type 14	Tipo 15 Type 15	Tipo 16 Type 16	Tipo 17/27 Type 17/27	
GR 1	18 (13.3)	18 (13.3)		30 (22.1)	30 (22.1)	30 (22.1)		12 (8.9)	18 (13.3)
GR 2	98 (72.3)	98 (72.3)	98 (72.3)	98 (72.3)	98 (72.3)	98 (72.3)	98 (72.3)	70 (51.6)	75 (55.3)
GR 3	240 (177)			240 (177)	240 (177)				240 (177)
GR 4	750 (553)								750 (553)



GAMMA DI PRODOTTO

PRODUCT RANGE

Standard
Con albero tipo 10
With shaft type 10

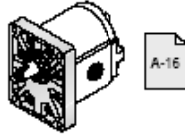

1^a pompa
1st pump

2^a (..3^a,..) pompa / 2nd (..3rd,..) pump

	4	3	2	1
1				0109110000000000 010911308680_00
2			0109220000000000 010922291890_00	0109211000000000 0109210100000000
3		0109330000000000 0109331000000000	0109320000000000 0109321000000000	0109311000000000 0109310100000000
4	0104400000000000	0104300000000000	0104200000000000	0104100000000000

Ad esaurimento / Phasing-out

Kit codice / Kit code
Tandem STANDARD
Tandem STANDARD
Tandem CORTO
SHORT Tandem

Standard



Standard

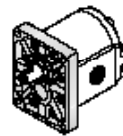

SAE B



SAE B-OR



ZFC

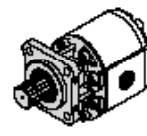

Standard



SAE A

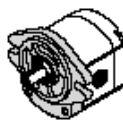

SAE A-OR

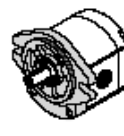

B80 C

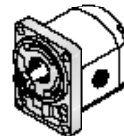

B50 C

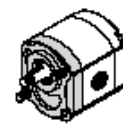

E52 C



SAE A 14*

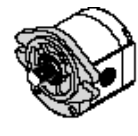

Standard

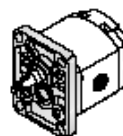

SAE AA

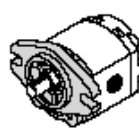

MC 32

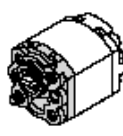

E 32 BX

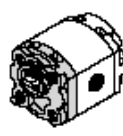

E 32 CX

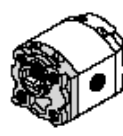

B-3



DESIGNAZIONE
Tandem STANDARD

Sono possibili combinazioni di tutti i gruppi pompa (Gr.1 - Gr.2 - Gr.3 e Gr.4)
L'aspirazione di ogni singola unità è indipendente.

DESIGNATION
Tandem STANDARD

Are possible different combinations of all the group pumps (Gr.1 - Gr.2 - Gr.3 and Gr.4).
The suction of each pump is independent.

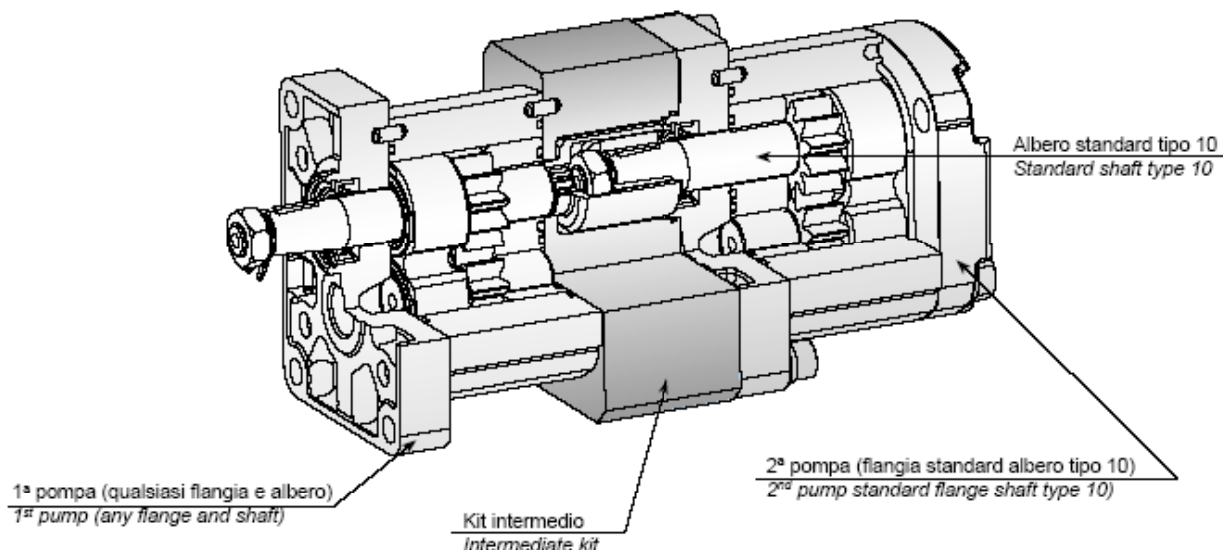

Esempio di ordinazione in codice / Example of ordering code

2SP A14 + 1SP A4.2 D SAE A - 10 G (VT)

2SP A14	Tipo prima pompa / First pump type	
1SP A4.2	Tipo seconda pompa / Second pump type	
D	Rotazione destra / Clockwise rotation	D = Rotazione destra / Clockwise rotation S = Rotazione sinistra / Anticlockwise rotation
SAE A	Tipo e versione flangia 1ª pompa / Flange and version first pump flange	
10	Tipo albero prima pompa / Shaft type first pump	Vedi pompa singola corrispondente (sez. A) See corresponding single pump
G	Tipo connessioni / Connections type	
(VT)	Opzioni / Optional	

Esempio di ordinazione in codice / Example of ordering code

3SP A36 + 2SP A14 + 1SP A3.2 D SAE B - 10 G (VT)

3SP A36	Tipo prima pompa / First pump type	
2SP A14	Tipo seconda pompa / Second pump type	
1SP A3.2	Tipo terza pompa / Third pump type	
D	Rotazione destra / Clockwise rotation	D = Rotazione destra / Clockwise rotation S = Rotazione sinistra / Anticlockwise rotation
SAE B	Tipo e versione flangia 1ª pompa / Flange and version first pump flange	
10	Tipo albero prima pompa / Shaft type first pump	Vedi pompa singola corrispondente (sez. A) See corresponding single pump
G	Tipo connessioni / Connections type	
(VT)	Opzioni / Optional	

Tandem CORTO

- Non possibile con pompe Gr.4.
- Dimensioni più contenute rispetto al tandem standard.
- Le aspirazioni dei vari stadi sono in comunione fra loro.
- Possibilità di aspirazione unica fra i vari stadi (consultare nostra società)

SHORT Tandem

- Not possible with Gr.4 pumps.
- Low dimensions respect to the standard tandem.
- The suctions of the different pumps are connected.
- Possibility to have only one suction among the different pumps (contact our factory)

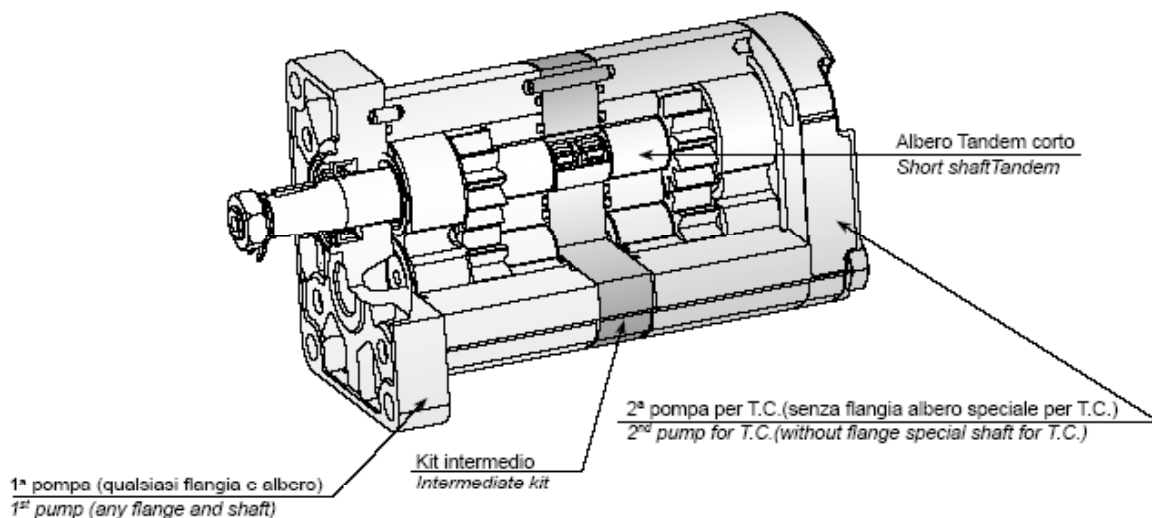

Esempio di ordinazione in codice / Example of ordering code

2SP A14 + 1SP A4.2 D TC SAE A - 10 G (VT)

2SP A14	Tipo prima pompa / First pump type	
1SP A4.2	Tipo seconda pompa / Second pump type	
D	Rotazione destra / Clockwise rotation	D = Rotazione destra / Clockwise rotation S = Rotazione sinistra / Anticlockwise rotation
TC	Tipo Tandem / Type Tandem	
SAE A	Tipo e versione flangia 1ª pompa / Flange and version first pump flange	
10	Tipo albero prima pompa / Shaft type first pump	Vedi pompa singola corrispondente (sez. A) See corresponding single pump
G	Tipo connessioni / Connections type	
(VT)	Opzioni / Optional	

Esempio di ordinazione in codice / Example of ordering code

3SP A36 + 2SP A14 + 1SP A3.2 D TC SAE B - 10 G (VT)

3SP A36	Tipo prima pompa / First pump type	
2SP A14	Tipo seconda pompa / Second pump type	
1SP A3.2	Tipo terza pompa / Third pump type	
D	Rotazione destra / Clockwise rotation	D = Rotazione destra / Clockwise rotation S = Rotazione sinistra / Anticlockwise rotation
TC	Tipo Tandem / Type Tandem	
SAE B	Tipo e versione flangia 1ª pompa / Flange and version first pump flange	
10	Tipo albero prima pompa / Shaft type first pump	Vedi pompa singola corrispondente (sez. A) See corresponding single pump
G	Tipo connessioni / Connections type	
(VT)	Opzioni / Optional	



GR 1 + GR 1

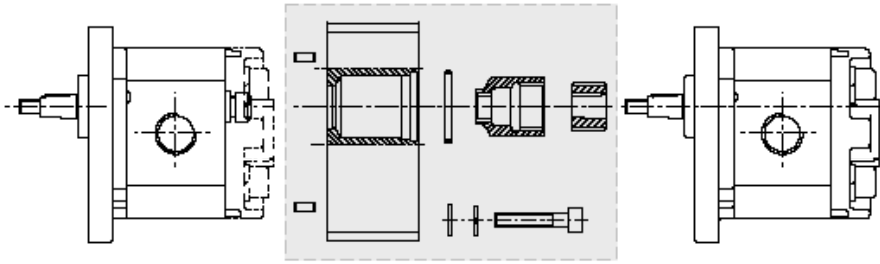

Codice ordinazione kit / kit order code **01091100000000**

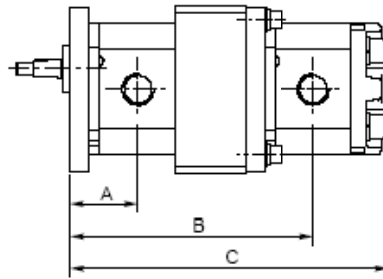

Codice ordinazione kit / kit order code **01091100000000**

		mm (inch)		
		A	B	C
1SP A9.8 +	A9.8	52.2 (2.053)	177.9 (7.006)	234.1 (9.217)
	A7.8	52.2 (2.053)	174.0 (6.850)	226.2 (8.906)
	A6.3	52.2 (2.053)	171.2 (6.738)	220.5 (8.681)
	A5.0	52.2 (2.053)	168.6 (6.638)	215.4 (8.480)
	A4.2	52.2 (2.053)	167.1 (6.577)	212.3 (8.358)
	A3.7	52.2 (2.053)	166.1 (6.539)	210.4 (8.283)
	A3.2	52.2 (2.053)	165.1 (6.500)	208.4 (8.205)
	A2.5	52.2 (2.053)	163.8 (6.447)	205.7 (8.098)
	A2.0	52.2 (2.053)	162.8 (6.407)	203.7 (8.020)
	A1.6	52.2 (2.053)	162.0 (6.378)	202.2 (7.961)
	A1.2	52.2 (2.053)	161.2 (6.344)	200.5 (7.894)
	A0.9	52.2 (2.053)	160.6 (6.323)	199.4 (7.850)

Codice ordinazione kit / kit order code **01091100000000**

		mm (inch)		
		A	B	C
1SPA7.8 +	A7.8	48.2 (1.898)	166.1 (6.539)	218.3 (8.594)
	A6.3	48.2 (1.898)	163.3 (6.427)	212.6 (8.370)
	A5.0	48.2 (1.898)	160.7 (6.327)	207.5 (8.169)
	A4.2	48.2 (1.898)	159.2 (6.266)	204.4 (8.047)
	A3.7	48.2 (1.898)	158.2 (6.228)	202.5 (7.972)
	A3.2	48.2 (1.898)	157.2 (6.189)	200.5 (7.894)
	A2.5	48.2 (1.898)	155.9 (6.136)	197.8 (7.787)
	A2.0	48.2 (1.898)	154.9 (6.096)	195.8 (7.709)
	A1.6	48.2 (1.898)	154.1 (6.067)	194.3 (7.650)
	A1.2	48.2 (1.898)	153.3 (6.033)	192.6 (7.583)
	A0.9	48.2 (1.898)	152.7 (6.012)	191.5 (7.539)

Con la flangia SAE AA incrementare le quote A, B, e C di 3.5 mm

With SAE AA flange increase A, B, and C dimensions of 0.138 inch



B.6

Codice ordinazione kit / kit order code **01091100000000**Codice ordinazione kit / kit order code **01091100000000**

		mm (inch)		
		A	B	C
1SP A6.3	A6.3	45.4 (1.785)	157.6 (6.203)	206.9 (8.146)
	A5.0	45.4 (1.785)	155.0 (6.102)	201.8 (7.945)
	A4.2	45.4 (1.785)	153.5 (6.041)	198.7 (7.823)
	A3.7	45.4 (1.785)	152.5 (6.004)	196.8 (7.748)
	A3.2	45.4 (1.785)	151.5 (5.965)	194.8 (7.669)
	A2.5	45.4 (1.785)	150.2 (5.911)	192.1 (7.563)
	A2.0	45.4 (1.785)	149.2 (5.872)	190.1 (7.484)
	A1.6	45.4 (1.785)	148.4 (5.843)	188.6 (7.425)
	A1.2	45.4 (1.785)	147.6 (5.809)	186.9 (7.358)
	A0.9	45.4 (1.785)	147.0 (5.787)	185.8 (7.315)
1SP A5.0	A5.0	42.8 (1.685)	149.9 (5.902)	196.7 (7.744)
	A4.2	42.8 (1.685)	148.4 (5.841)	193.6 (7.622)
	A3.7	42.8 (1.685)	147.4 (5.803)	191.7 (7.547)
	A3.2	42.8 (1.685)	146.4 (5.764)	189.7 (7.469)
	A2.5	42.8 (1.685)	145.1 (5.711)	187.0 (7.362)
	A2.0	42.8 (1.685)	144.1 (5.671)	185.0 (7.283)
	A1.6TC	42.8 (1.685)	143.3 (5.642)	183.5 (7.224)
	A1.2TC	42.8 (1.685)	142.5 (5.608)	181.8 (7.157)
	A0.9TC	42.8 (1.685)	141.9 (5.587)	180.7 (7.114)
	1SP A4.2	A4.2TC	41.3 (1.624)	145.3 (5.719)
A3.7TC		41.3 (1.624)	144.3 (5.681)	188.6 (7.425)
A3.2TC		41.3 (1.624)	143.3 (5.642)	186.6 (7.346)
A2.5TC		41.3 (1.624)	141.9 (5.589)	183.9 (7.240)
A2.0TC		41.3 (1.624)	140.9 (5.549)	181.9 (7.161)
1SP A3.7	A1.6TC	41.3 (1.624)	140.2 (5.520)	180.4 (7.102)
	A1.2TC	41.3 (1.624)	139.4 (5.486)	178.7 (7.035)
	A0.9TC	41.3 (1.624)	138.8 (5.465)	177.6 (6.992)

		mm (inch)			
		A	B	C	
1SP A3.7	A3.7TC	40.3 (1.587)	142.4 (5.606)	186.7 (7.350)	
	A3.2TC	40.3 (1.587)	141.4 (5.567)	184.7 (7.272)	
	A2.5TC	40.3 (1.587)	140.1 (5.514)	182.0 (7.165)	
	A2.0TC	40.3 (1.587)	139.1 (5.474)	180.0 (7.087)	
	A1.6TC	40.3 (1.587)	138.3 (5.445)	178.5 (7.028)	
	A1.2TC	40.3 (1.587)	137.5 (5.411)	176.8 (6.961)	
	A0.9TC	40.3 (1.587)	136.9 (5.390)	175.7 (6.917)	
	1SP A3.2	A3.2TC	39.3 (1.547)	139.4 (5.488)	182.7 (7.193)
		A2.5TC	39.3 (1.547)	138.1 (5.435)	180.0 (7.087)
		A2.0TC	39.3 (1.547)	137.1 (5.396)	178.0 (7.008)
A1.6TC		39.3 (1.547)	136.3 (5.366)	176.5 (6.949)	
A1.2TC		39.3 (1.547)	135.5 (5.333)	174.8 (6.882)	
A0.9TC		39.3 (1.547)	134.9 (5.311)	173.7 (6.839)	
1SP A2.5		A2.5TC	37.9 (1.494)	135.4 (5.329)	177.3 (6.980)
		A2.0TC	37.9 (1.494)	134.4 (5.289)	175.3 (6.902)
		A1.6TC	37.9 (1.494)	133.6 (5.260)	173.8 (6.843)
		A1.2TC	37.9 (1.494)	132.8 (5.226)	172.1 (6.776)
	A0.9TC	37.9 (1.494)	132.2 (5.205)	171.0 (6.732)	
	1SP A2.0	A2.0TC	36.9 (1.455)	132.4 (5.211)	173.3 (6.823)
		A1.6TC	36.9 (1.455)	131.6 (5.181)	171.8 (6.764)
		A1.2TC	36.9 (1.455)	130.8 (5.149)	170.1 (6.697)
		A0.9TC	36.9 (1.455)	130.2 (5.126)	169.0 (6.654)
		1SP A1.6	A1.6TC	36.2 (1.425)	130.1 (5.122)
A1.2TC	36.2 (1.425)		129.3 (5.089)	168.6 (6.638)	
A0.9TC	36.2 (1.425)		128.7 (5.067)	167.5 (6.594)	
1SP A1.2	A1.2TC		35.4 (1.392)	127.6 (5.022)	166.9 (6.571)
	A0.9TC		35.35 (1.392)	127.0 (5.000)	165.8 (6.528)
	1SP A0.9	A0.9TC	34.8 (1.370)	125.9 (4.957)	164.7 (6.484)

GR 1 + GR 1 TC

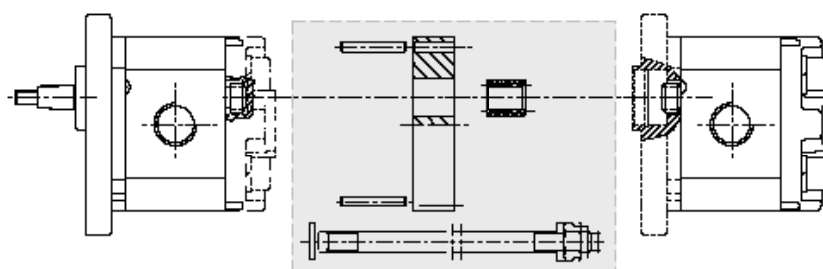

Codice ordinazione kit / kit order code

Il Kit standard viene fornito con tiranti e dadi autobloccanti (max. ingombro C); se le pompe tandem sono fornite già assemblate, l'ingombro C è leggermente inferiore in quanto vengono utilizzate viti TCEI (consultare il ns. servizio tecnico per avere gli ingombri esatti).

The standard Kit is supplied with tension rods and self-locking nuts (max. dimension C); if the tandem pumps are supplied already assembled, the external dimensions of C are slightly less because socket-head screws are used (contact our technical service for the exact dimensions).

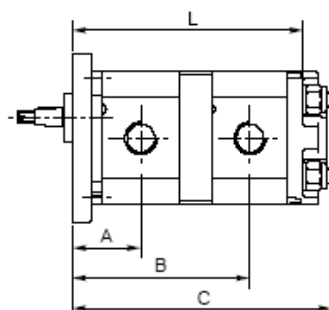

		mm (inch)			
		A	B	C	L*
Codice ordinazione kit / kit order code		010911308680600			
A9.8 TC		52.2 (2.053)	141.5 (5.569)	200.5 (7.894)	185.6 (7.307)
A7.8 TC		52.2 (2.053)	137.5 (5.413)	200.5 (7.894)	177.7 (6.996)
Codice ordinazione kit / kit order code		010911308680500			
A6.3 TC		52.2 (2.053)	134.7 (5.301)	188.5 (7.421)	172.0 (6.772)
A5.0 TC		52.2 (2.053)	132.1 (5.201)	188.5 (7.421)	166.9 (6.571)
Codice ordinazione kit / kit order code		010911308680400			
A4.2 TC		52.2 (2.053)	130.6 (5.140)	176.5 (6.949)	163.8 (6.449)
1SP A9.8 + A3.7 TC		52.2 (2.053)	129.6 (5.102)	176.5 (6.949)	161.9 (6.374)
A3.2 TC		52.2 (2.053)	128.6 (5.063)	176.5 (6.949)	159.9 (6.295)
A2.5 TC		52.2 (2.053)	127.3 (5.010)	176.5 (6.949)	157.2 (6.189)
A2.0 TC		52.2 (2.053)	126.3 (4.970)	176.5 (6.949)	155.2 (6.110)
Codice ordinazione kit / kit order code		010911308680300			
A1.6 TC		52.2 (2.053)	125.5 (4.941)	165.7 (6.524)	153.7 (6.051)
A1.2 TC		52.2 (2.053)	124.7 (4.907)	164.5 (6.476)	152.0 (5.984)
A0.9 TC		52.2 (2.053)	124.1 (4.886)	164.5 (6.476)	150.9 (5.941)

		mm (inch)			
		A	B	C	L*
Codice ordinazione kit / kit order code		010911308680500			
A7.8 TC		48.2 (1.898)	129.6 (5.102)	188.5 (7.421)	169.8 (6.685)
Codice ordinazione kit / kit order code		010911308680400			
A6.3 TC		48.2 (1.898)	126.8 (4.990)	176.5 (6.949)	164.1 (6.461)
A5.0 TC		48.2 (1.898)	124.2 (4.890)	176.5 (6.949)	159.0 (6.260)
A4.2 TC		48.2 (1.898)	122.7 (4.829)	176.5 (6.949)	155.9 (6.138)
A3.7 TC		48.2 (1.898)	121.7 (4.791)	176.5 (6.949)	154.0 (6.063)
1SP A7.8 +		48.2 (1.898)	120.7 (4.752)	164.5 (6.476)	152.0 (5.984)
A3.2 TC		48.2 (1.898)	119.4 (4.699)	164.5 (6.476)	149.3 (5.878)
A2.5 TC		48.2 (1.898)	118.4 (4.659)	164.5 (6.476)	147.3 (5.799)
A2.0 TC		48.2 (1.898)	117.6 (4.630)	164.5 (6.476)	145.8 (5.740)
A1.6 TC		48.2 (1.898)	116.8 (4.596)	164.5 (6.476)	144.1 (5.673)
A1.2 TC		48.2 (1.898)	116.2 (4.575)	164.5 (6.476)	143.0 (5.630)
A0.9 TC		48.2 (1.898)	116.2 (4.575)	164.5 (6.476)	143.0 (5.630)

Con la flangia SAE AA incrementare le quote A, B e C di 3.5 mm
* La quota L serve per il fissaggio di pompe con flangia E32 ed MC32

With SAE AA flange increase A, B, and C dimensions of 0.138 inch
* The L dimension is necessary for the facing of pumps with E32 ed MC32 flange only



		mm (inch)			
		A	B	C	L*
Codice ordinazione kit / kit order code 010911308680400					
A6.3 TC		45.4	121.1	176.5	158.4
		(1.785)	(4.766)	(6.949)	(6.236)
Codice ordinazione kit / kit order code 010911308680300					
A5.0 TC		45.4	118.5	165.3	153.3
		(1.785)	(4.665)	(6.508)	(6.035)
A4.2 TC		45.4	116.9	164.5	150.2
		(1.785)	(4.604)	(6.476)	(5.913)
A3.7 TC		45.4	116.0	164.5	148.3
		(1.785)	(4.567)	(6.476)	(5.839)
A3.2 TC		45.4	115.0	164.5	146.3
		(1.785)	(4.528)	(6.476)	(5.760)
A2.5 TC		45.4	113.7	164.5	143.6
		(1.785)	(4.474)	(6.476)	(5.654)
Codice ordinazione kit / kit order code 010911308680200					
A2.0 TC		45.4	112.7	153.6	141.6
		(1.785)	(4.435)	(6.047)	(5.575)
A1.6 TC		45.4	111.9	152.5	140.1
		(1.785)	(4.406)	(6.004)	(5.516)
A1.2 TC		45.4	111.1	152.5	138.4
		(1.785)	(4.372)	(6.004)	(5.449)
A0.9 TC		45.4	110.5	152.5	137.3
		(1.785)	(4.350)	(6.004)	(5.406)
Codice ordinazione kit / kit order code 010911308680300					
A5.0 TC		42.8	113.4	164.5	148.5
		(1.685)	(4.465)	(6.476)	(5.846)
A4.2 TC		42.8	111.9	164.5	145.1
		(1.685)	(4.404)	(6.476)	(5.713)
A3.7 TC		42.8	110.9	164.5	143.2
		(1.685)	(4.366)	(6.476)	(5.638)
Codice ordinazione kit / kit order code 010911308680200					
A3.2 TC		42.8	109.9	153.2	141.2
		(1.685)	(4.327)	(6.032)	(5.559)
A2.5 TC		42.8	108.6	152.5	138.5
		(1.685)	(4.274)	(6.004)	(5.453)
A2.0 TC		42.8	107.6	152.5	136.5
		(1.685)	(4.234)	(6.004)	(5.374)
Codice ordinazione kit / kit order code 010911308680200					
A1.6 TC		42.8	106.8	152.5	135.0
		(1.685)	(4.205)	(6.004)	(5.315)
A1.2 TC		42.8	105.9	152.5	133.3
		(1.685)	(4.171)	(6.004)	(5.248)
A0.9 TC		42.8	105.4	152.5	132.2
		(1.685)	(4.150)	(6.004)	(5.205)
Codice ordinazione kit / kit order code 010911308680300					
A4.2 TC		41.3	108.8	164.5	142.0
		(1.624)	(4.282)	(6.476)	(5.591)
Codice ordinazione kit / kit order code 010911308680200					
A3.7 TC		41.3	107.8	152.5	140.1
		(1.624)	(4.244)	(6.004)	(5.516)
A3.2 TC		41.3	106.8	152.5	138.1
		(1.624)	(4.205)	(6.004)	(5.437)
A2.5 TC		41.3	105.5	152.5	135.4
		(1.624)	(4.152)	(6.004)	(5.331)
A2.0 TC		41.3	104.5	152.5	133.4
		(1.624)	(4.112)	(6.004)	(5.252)
A1.6 TC		41.3	103.7	152.5	131.9
		(1.624)	(4.083)	(6.004)	(5.193)
A1.2 TC		41.3	102.9	152.5	130.2
		(1.624)	(4.049)	(6.004)	(5.126)
Codice ordinazione kit / kit order code 010911308680100					
A0.9 TC		41.3	102.3	141.1	129.1
		(1.624)	(4.028)	(5.555)	(5.083)

		mm (inch)			
		A	B	C	L*
Codice ordinazione kit / kit order code 010911308680200					
A3.7 TC		40.3	105.9	152.5	138.2
		(1.587)	(4.169)	(6.004)	(5.441)
A3.2 TC		40.3	104.9	152.5	136.2
		(1.587)	(4.130)	(6.004)	(5.362)
A2.5 TC		40.3	103.6	152.5	133.5
		(1.587)	(4.077)	(6.004)	(5.256)
A2.0 TC		40.3	102.6	152.5	131.5
		(1.587)	(4.037)	(6.004)	(5.177)
A1.6 TC		40.3	101.8	152.5	130.0
		(1.587)	(4.008)	(6.004)	(5.118)
Codice ordinazione kit / kit order code 010911308680100					
A1.2 TC		40.3	100.9	140.5	128.3
		(1.587)	(3.974)	(5.532)	(5.051)
A0.9 TC		40.3	100.4	140.5	127.2
		(1.587)	(3.953)	(5.532)	(5.008)
Codice ordinazione kit / kit order code 010911308680200					
A3.2 TC		39.3	107.9	152.5	134.2
		(1.547)	(4.051)	(6.004)	(5.283)
A2.5 TC		39.3	101.6	152.5	131.5
		(1.547)	(3.998)	(6.004)	(5.177)
Codice ordinazione kit / kit order code 010911308680100					
A2.0 TC		39.3	100.6	141.50	129.5
		(1.547)	(3.959)	(5.571)	(5.098)
A1.6 TC		39.3	99.8	140.5	128.0
		(1.547)	(3.929)	(5.532)	(5.039)
A1.2 TC		39.3	98.9	140.5	126.3
		(1.547)	(3.896)	(5.532)	(4.972)
A0.9 TC		39.3	98.4	140.5	125.2
		(1.547)	(3.874)	(5.532)	(4.929)
Codice ordinazione kit / kit order code 010911308680100					
A2.5 TC		37.9	98.9	140.8	128.8
		(1.494)	(3.892)	(5.543)	(5.071)
A2.0 TC		37.9	97.9	140.5	126.8
		(1.494)	(3.852)	(5.532)	(4.992)
A1.6 TC		37.9	97.1	140.5	125.3
		(1.494)	(3.823)	(5.532)	(4.933)
A1.2 TC		37.9	96.3	140.5	123.6
		(1.494)	(3.789)	(5.532)	(4.866)
A0.9 TC		37.9	95.7	140.5	122.5
		(1.494)	(3.768)	(5.532)	(4.823)
Codice ordinazione kit / kit order code 010911308680100					
A2.0 TC		36.9	95.9	140.5	124.8
		(1.455)	(3.774)	(5.532)	(4.913)
A1.6 TC		36.9	95.1	140.5	123.3
		(1.455)	(3.744)	(5.532)	(4.854)
A1.2 TC		36.9	94.3	140.5	121.6
		(1.455)	(3.711)	(5.532)	(4.787)
A0.9 TC		36.9	93.7	140.5	120.5
		(1.455)	(3.689)	(5.532)	(4.744)
Codice ordinazione kit / kit order code 010911308680100					
A1.6 TC		36.2	93.6	140.5	121.8
		(1.425)	(3.685)	(5.532)	(4.795)
A1.2 TC		36.2	92.8	140.5	120.1
		(1.425)	(3.652)	(5.532)	(4.728)
A0.9 TC		36.2	92.2	140.5	119.0
		(1.425)	(3.630)	(5.532)	(4.685)
Codice ordinazione kit / kit order code 010911308680100					
A1.2 TC		35.4	91.1	140.5	118.4
		(1.392)	(3.585)	(5.532)	(4.661)
A0.9 TC		35.4	90.5	140.5	117.3
		(1.392)	(3.563)	(5.532)	(4.618)
Codice ordinazione kit / kit order code 010911308680100					
A0.9 TC		34.8	89.4	140.5	116.2
		(1.370)	(3.520)	(5.532)	(4.575)

GR 1 + GR 1 + GR 1 TC

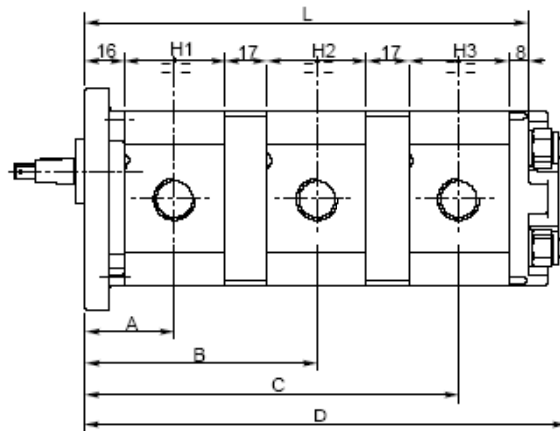

	mm (inch)			
	H1	H2	H3	L
1SP A9.8		72.3 (2.846)		...
1SP A7.8		64.4 (2.535)		...
1SP A6.3		58.7 (2.311)		...
1SP A5.0		53.6 (2.110)		...
1SP A4.2		50.5 (1.988)		...
1SP A3.7		48.6 (1.913)		...
1SP A3.2		46.6 (1.835)		...
1SP A2.5		43.9 (1.728)		...
1SP A2.0		41.9 (1.650)		...
1SP A1.6		40.4 (1.591)		...
1SP A1.2		38.7 (1.524)		...
1SP A0.9		37.6 (1.480)		...

Con la flangia SAE AA incrementare le quote A, B, e C di 3.5 mm

	mm (inch)	
	L	D
L < 179.5 (7.067)		188.5 ^{+1.5} ₀ (7.421) ^{+0.050} ₀
179.6 < L < 191.4 (7.071) < L < (7.535)		200.5 ^{+1.5} ₀ (7.894) ^{+0.050} ₀
191.5 < L < 206.4 (7.539) < L < (8.126)		215.5 ^{+1.5} ₀ (8.484) ^{+0.050} ₀
206.5 < L < 220 (8.130) < L < (8.661)		229.5 ^{+1.5} ₀ (9.035) ^{+0.050} ₀
220.1 < L < 235.5 (8.665) < L < (9.272)		243.5 ^{+1.5} ₀ (9.597) ^{+0.050} ₀
235.6 < L < 249.5 (9.276) < L < (9.823)		258.5 ^{+1.5} ₀ (10.177) ^{+0.050} ₀
249.6 < L < 262 (9.827) < L < (10.315)		271.5 ^{+1.5} ₀ (10.689) ^{+0.050} ₀
262.1 < L (10.280) < L		287.5 ^{+1.5} ₀ (11.319) ^{+0.050} ₀

With SAE AA flange increase A, B, and C dimensions of 0.138 inch

Esempio di ordinazione in codice / Example of ordering code

1SP A6.3 + A2.5 + A1.2 D TC ...⁽¹⁾ - ...⁽²⁾ ...⁽³⁾

1SP A6.3	Tipo prima pompa / First pump type	vedi tabelle / see tables
A2.5	Tipo seconda pompa / Second pump type	vedi tabelle / see tables
A1.2	Tipo terza pompa / Third pump type	vedi tabelle / see tables
D	Rotazione destra / Clockwise rotation	D = Rotazione destra / Clockwise rotation S = Rotazione sinistra / Anticlockwise rotation
TC	Tipo tandem / Type tandem	
... ⁽¹⁾	Tipo ed eventuale versione flangia standard 1ª pompa Type and version first pump flange	
... ⁽²⁾	Tipo albero / Shaft type	Vedi pompa singola corrispondente See corresponding single pump
... ⁽³⁾	Tipo connessioni / Connections type	Vedi pompa singola corrispondente See corresponding single pump

GR 2 + GR 1

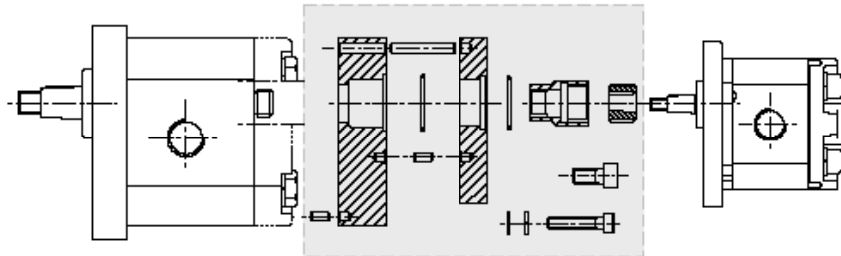

Codice ordinazione kit / kit order code **01092110000000**

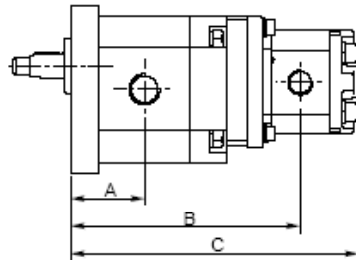

Codice ordinazione kit / kit order code **01092110000000**

		mm (inch)		
		A	B	C
2SP...26	9.8	62.7 (2.469)	198.1 (7.797)	254.2 (10.008)
	7.8	62.7 (2.469)	194.1 (7.642)	246.3 (9.697)
	6.3	62.7 (2.469)	191.3 (7.530)	240.6 (9.472)
	5	62.7 (2.469)	188.7 (7.429)	235.5 (9.272)
	4.2	62.7 (2.469)	187.2 (7.368)	232.4 (9.150)
	3.7	62.7 (2.469)	186.2 (7.331)	230.5 (9.075)
	3.2	62.7 (2.469)	185.2 (7.291)	228.5 (8.996)
	2.5	62.7 (2.469)	183.9 (7.238)	225.8 (8.890)
	2	62.7 (2.469)	182.9 (7.199)	223.8 (8.811)
	1.6	62.7 (2.469)	182.1 (7.169)	222.3 (8.752)
	1.2	62.7 (2.469)	181.3 (7.136)	220.6 (8.685)
0.9	62.7 (2.469)	180.7 (7.114)	219.5 (8.642)	

Con la flangia B80C incrementare le quote A, B e C di 2 mm
Con la flangia E52C diminuire le quote A, B e C di 2.7 mm

Codice ordinazione kit / kit order code **01092110000000**

		mm (inch)		
		A	B	C
2SP...22	9.8	59.8 (2.354)	192.3 (7.569)	248.4 (9.780)
	7.8	59.8 (2.354)	188.3 (7.413)	240.5 (9.469)
	6.3	59.8 (2.354)	185.5 (7.301)	234.8 (9.244)
	5	59.8 (2.354)	182.9 (7.201)	229.7 (9.043)
	4.2	59.8 (2.354)	181.4 (7.140)	226.6 (8.921)
	3.7	59.8 (2.354)	180.4 (7.102)	224.7 (8.846)
	3.2	59.8 (2.354)	179.4 (7.063)	222.7 (8.768)
	2.5	59.8 (2.354)	178.05 (7.010)	220.0 (8.661)
	2	59.8 (2.354)	177.1 (6.970)	218.0 (8.583)
	1.6	59.8 (2.354)	176.3 (6.941)	216.5 (8.524)
	1.2	59.8 (2.354)	175.5 (6.907)	214.8 (8.457)
0.9	59.8 (2.354)	174.9 (6.886)	213.7 (8.413)	

With B80C flange increase A, B, and C dimensions of 0.079 inch
With E52C flange decrease A, B, and C dimensions of 0.106 inch

GR 2 + GR 1

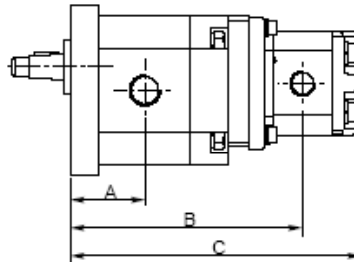

Codice ordinazione kit / kit order code **010921100000000**

Codice ordinazione kit / kit order code **010921100000000**

		mm (inch)		
		A	B	C
2SP...19 + 1SPA	9.8	57.3 (2.256)	187.3 (7.372)	243.4 (9.583)
	7.8	57.3 (2.256)	183.3 (7.217)	235.5 (9.272)
	6.3	57.3 (2.256)	180.5 (7.104)	229.8 (9.047)
	5	57.3 (2.256)	177.9 (7.004)	224.7 (8.846)
	4.2	57.3 (2.256)	176.4 (6.943)	221.6 (8.724)
	3.7	57.3 (2.256)	175.4 (6.906)	219.7 (8.650)
	3.2	57.3 (2.256)	174.4 (6.866)	217.7 (8.571)
	2.5	57.3 (2.256)	173.1 (6.813)	215.0 (8.465)
	2	57.3 (2.256)	172.1 (6.774)	213.0 (8.386)
	1.6	57.3 (2.256)	171.3 (6.744)	211.5 (8.327)
	1.2	57.3 (2.256)	170.5 (6.711)	209.8 (8.260)
	0.9	57.3 (2.256)	169.9 (6.689)	208.7 (8.217)
2SP...16 + 1SPA	9.8	54.8 (2.157)	182.3 (7.175)	238.4 (9.386)
	7.8	54.8 (2.157)	178.3 (7.020)	230.5 (9.075)
	6.3	54.8 (2.157)	175.5 (6.907)	224.8 (8.850)
	5	54.8 (2.157)	172.9 (6.807)	219.7 (8.650)
	4.2	54.8 (2.157)	171.4 (6.746)	216.6 (8.528)
	3.7	54.8 (2.157)	170.4 (6.709)	214.7 (8.453)
	3.2	54.8 (2.157)	169.4 (6.669)	212.7 (8.374)
	2.5	54.8 (2.157)	168.1 (6.616)	210.0 (8.268)
	2	54.8 (2.157)	167.1 (6.577)	208.0 (8.189)
	1.6	54.8 (2.157)	166.3 (6.547)	206.5 (8.130)
	1.2	54.8 (2.157)	165.5 (6.514)	204.8 (8.063)
	0.9	54.8 (2.157)	164.9 (6.492)	203.7 (8.020)

		mm (inch)		
		A	B	C
2SP...14 + 1SPA	9.8	52.7 (2.075)	178.1 (7.010)	234.2 (9.220)
	7.8	52.7 (2.075)	174.1 (6.854)	226.3 (8.909)
	6.3	52.7 (2.075)	171.3 (6.742)	220.6 (8.685)
	5	52.7 (2.075)	168.7 (6.642)	215.5 (8.484)
	4.2	52.7 (2.075)	167.2 (6.581)	212.4 (8.362)
	3.7	52.7 (2.075)	166.2 (6.543)	210.5 (8.287)
	3.2	52.7 (2.075)	165.2 (6.504)	208.5 (8.209)
	2.5	52.7 (2.075)	163.9 (6.451)	205.8 (8.102)
	2	52.7 (2.075)	162.9 (6.411)	203.8 (8.024)
	1.6	52.7 (2.075)	162.1 (6.382)	202.3 (7.965)
	1.2	52.7 (2.075)	161.3 (6.348)	200.6 (7.898)
	0.9	52.7 (2.075)	160.7 (6.327)	199.5 (7.854)
2SP...11 + 1SPA	9.8	50.2 (1.976)	173.1 (6.813)	229.2 (9.024)
	7.8	50.2 (1.976)	169.1 (6.657)	221.3 (8.713)
	6.3	50.2 (1.976)	166.3 (6.545)	215.6 (8.488)
	5	50.2 (1.976)	163.7 (6.445)	210.5 (8.287)
	4.2	50.2 (1.976)	162.2 (6.384)	207.4 (8.165)
	3.7	50.2 (1.976)	161.2 (6.346)	205.5 (8.091)
	3.2	50.2 (1.976)	160.2 (6.307)	203.5 (8.012)
	2.5	50.2 (1.976)	158.9 (6.254)	200.8 (7.906)
	2	50.2 (1.976)	157.9 (6.215)	198.8 (7.827)
	1.6	50.2 (1.976)	157.1 (6.185)	197.3 (7.768)
	1.2	50.2 (1.976)	156.3 (6.152)	195.6 (7.701)
	0.9	50.2 (1.976)	155.7 (6.130)	194.5 (7.657)

GR 2 + GR 1

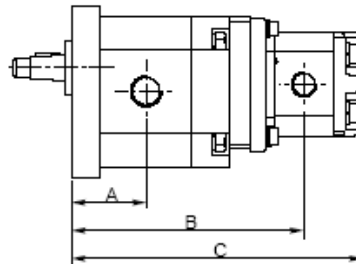

Codice ordinazione kit / kit order code **010921100000000**

Codice ordinazione kit / kit order code **010921100000000**

		mm (inch)			
		A	B	C	
2SP...8	+ 1SPA	9.8	48.2 (1.896)	168.9 (6.652)	225.1 (8.862)
		7.8	48.2 (1.896)	165.0 (6.496)	217.2 (8.551)
		6.3	48.2 (1.896)	162.2 (6.384)	211.5 (8.327)
		5	48.2 (1.896)	159.6 (6.283)	206.4 (8.126)
		4.2	48.2 (1.896)	158.1 (6.222)	203.3 (8.004)
		3.7	48.2 (1.896)	157.1 (6.185)	201.4 (7.929)
		3.2	48.2 (1.896)	156.1 (6.146)	199.4 (7.850)
		2.5	48.2 (1.896)	154.8 (6.093)	196.7 (7.744)
		2	48.2 (1.896)	153.8 (6.053)	194.7 (7.665)
		1.6	48.2 (1.896)	153.0 (6.024)	193.2 (7.606)
		1.2	48.2 (1.896)	152.2 (5.990)	191.5 (7.539)
		0.9	48.2 (1.896)	151.6 (5.969)	190.4 (7.496)
2SP...6	+ 1SPA	9.8	46.1 (1.813)	164.8 (6.486)	220.9 (8.697)
		7.8	46.1 (1.813)	160.8 (6.331)	213.0 (8.386)
		6.3	46.1 (1.813)	157.9 (6.219)	207.3 (8.161)
		5	46.1 (1.813)	155.4 (6.118)	202.2 (7.961)
		4.2	46.1 (1.813)	153.9 (6.057)	199.1 (7.839)
		3.7	46.1 (1.813)	152.9 (6.020)	197.2 (7.764)
		3.2	46.1 (1.813)	151.9 (5.980)	195.2 (7.685)
		2.5	46.1 (1.813)	150.6 (5.927)	192.5 (7.579)
		2	46.1 (1.813)	149.6 (5.888)	190.5 (7.500)
		1.6	46.1 (1.813)	148.8 (5.858)	189.0 (7.441)
		1.2	46.1 (1.813)	147.9 (5.825)	187.3 (7.374)
		0.9	46.1 (1.813)	147.4 (5.803)	186.2 (7.331)

		mm (inch)			
		A	B	C	
2SP...4	+ 1SPA	9.8	44.4 (1.748)	168.9 (6.652)	217.6 (8.567)
		7.8	44.4 (1.748)	194.1 (7.642)	209.7 (8.256)
		6.3	44.4 (1.748)	191.3 (7.530)	204.0 (8.032)
		5	44.4 (1.748)	188.7 (7.429)	198.9 (7.831)
		4.2	44.4 (1.748)	187.2 (7.368)	195.8 (7.709)
		3.7	44.4 (1.748)	186.2 (7.331)	193.9 (7.634)
		3.2	44.4 (1.748v)	185.2 (7.291)	191.9 (7.555)
		2.5	44.4 (1.748)	183.9 (7.238)	189.2 (7.449)
		2	44.4 (1.748)	182.9 (7.199)	187.2 (7.370)
		1.6	44.4 (1.748)	182.1 (7.169)	185.7 (7.311)
		1.2	44.4 (1.748)	181.3 (7.136)	184.0 (7.244)
		0.9	44.4 (1.748)	180.7 (7.114)	182.9 (7.201)

Con la flangia B80C incrementare le quote A, B e C di 2 mm
Con la flangia E52C diminuire le quote A, B e C di 2.7 mm

With B80C flange increase A, B, and C dimensions of 0.079 inch
With E52C flange decrease A, B, and C dimensions of 0.106 inch



GR 2 + GR 1 TC

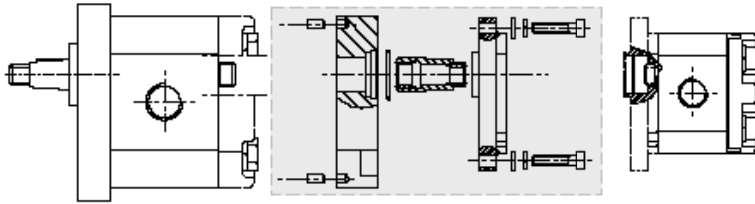

Codice ordinazione kit / kit order code **010921010000000**

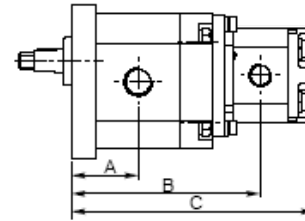

Codice ordinazione kit / kit order code **010921010000000**

		mm (inch)			
		A	B	C	
2SP...26	+ 1SPA	9.8TC	62.7 (2.469)	182.1 (7.167)	238.2 (9.378)
		7.8TC	62.7 (2.469)	178.1 (7.012)	230.3 (9.067)
		6.3TC	62.7 (2.469)	175.3 (6.900)	224.6 (8.843)
		5.0TC	62.7 (2.469)	172.7 (6.799)	219.5 (8.642)
		4.2TC	62.7 (2.469)	171.2 (6.738)	216.4 (8.520)
		3.7TC	62.7 (2.469)	170.2 (6.701)	214.5 (8.445)
		3.2TC	62.7 (2.469)	169.2 (6.661)	212.5 (8.366)
		2.5TC	62.7 (2.469)	167.9 (6.608)	209.8 (8.260)
		2.0TC	62.7 (2.469)	166.9 (6.569)	207.8 (8.181)
		1.6TC	62.7 (2.469)	166.1 (6.539)	206.3 (8.122)
2SP...22	+ 1SPA	9.8TC	59.8 (2.354)	176.3 (6.939)	232.4 (9.150)
		7.8TC	59.8 (2.354)	172.3 (6.783)	224.5 (8.839)
		6.3TC	59.8 (2.354)	169.5 (6.671)	218.8 (8.614)
		5.0TC	59.8 (2.354)	166.9 (6.571)	213.7 (8.413)
		4.2TC	59.8 (2.354)	165.4 (6.510)	210.6 (8.291)
		3.7TC	59.8 (2.354)	164.4 (6.472)	208.7 (8.217)
		3.2TC	59.8 (2.354)	163.4 (6.433)	206.7 (8.138)
		2.5TC	59.8 (2.354)	162.1 (6.380)	204.0 (8.032)
		2.0TC	59.8 (2.354)	161.1 (6.341)	202.0 (7.953)
		1.6TC	59.8 (2.354)	160.3 (6.311)	200.5 (7.894)
2SP...19	+ 1SPA	9.8TC	57.3 (2.256)	171.3 (6.742)	227.4 (8.953)
		7.8TC	57.3 (2.256)	167.3 (6.587)	219.5 (8.642)
		6.3TC	57.3 (2.256)	164.5 (6.474)	213.8 (8.417)
		5.0TC	57.3 (2.256)	161.9 (6.374)	208.7 (8.217)
		4.2TC	57.3 (2.256)	160.4 (6.313)	205.6 (8.094)
		3.7TC	57.3 (2.256)	159.4 (6.276)	203.7 (8.020)
		3.2TC	57.3 (2.256)	158.4 (6.236)	201.7 (7.941)
		2.5TC	57.3 (2.256)	157.1 (6.183)	199.0 (7.835)
		2.0TC	57.3 (2.256)	156.1 (6.144)	197.0 (7.756)
		1.6TC	57.3 (2.256)	155.3 (6.114)	195.5 (7.697)
2SP...16	+ 1SPA	9.8TC	54.8 (2.157)	166.3 (6.545)	222.4 (8.756)
		7.8TC	54.8 (2.157)	162.3 (6.390)	214.5 (8.445)
		6.3TC	54.8 (2.157)	159.5 (6.278)	208.8 (8.220)
		5.0TC	54.8 (2.157)	156.9 (6.177)	203.7 (8.020)
		4.2TC	54.8 (2.157)	155.4 (6.116)	200.6 (7.898)
		3.7TC	54.8 (2.157)	154.4 (6.079)	198.7 (7.823)
		3.2TC	54.8 (2.157)	153.4 (6.039)	196.7 (7.744)
		2.5TC	54.8 (2.157)	152.1 (5.986)	194.0 (7.638)
		2.0TC	54.8 (2.157)	151.1 (5.947)	192.0 (7.559)
		1.6TC	54.8 (2.157)	150.3 (5.917)	190.5 (7.500)

Codice ordinazione kit / kit order code **010921010000000**

		mm (inch)			
		A	B	C	
2SP...26	+ 1SPA	9.8TC	62.7 (2.469)	182.1 (7.167)	238.2 (9.378)
		7.8TC	62.7 (2.469)	178.1 (7.012)	230.3 (9.067)
		6.3TC	62.7 (2.469)	175.3 (6.900)	224.6 (8.843)
		5.0TC	62.7 (2.469)	172.7 (6.799)	219.5 (8.642)
		4.2TC	62.7 (2.469)	171.2 (6.738)	216.4 (8.520)
		3.7TC	62.7 (2.469)	170.2 (6.701)	214.5 (8.445)
		3.2TC	62.7 (2.469)	169.2 (6.661)	212.5 (8.366)
		2.5TC	62.7 (2.469)	167.9 (6.608)	209.8 (8.260)
		2.0TC	62.7 (2.469)	166.9 (6.569)	207.8 (8.181)
		1.6TC	62.7 (2.469)	166.1 (6.539)	206.3 (8.122)
2SP...22	+ 1SPA	9.8TC	59.8 (2.354)	176.3 (6.939)	232.4 (9.150)
		7.8TC	59.8 (2.354)	172.3 (6.783)	224.5 (8.839)
		6.3TC	59.8 (2.354)	169.5 (6.671)	218.8 (8.614)
		5.0TC	59.8 (2.354)	166.9 (6.571)	213.7 (8.413)
		4.2TC	59.8 (2.354)	165.4 (6.510)	210.6 (8.291)
		3.7TC	59.8 (2.354)	164.4 (6.472)	208.7 (8.217)
		3.2TC	59.8 (2.354)	163.4 (6.433)	206.7 (8.138)
		2.5TC	59.8 (2.354)	162.1 (6.380)	204.0 (8.032)
		2.0TC	59.8 (2.354)	161.1 (6.341)	202.0 (7.953)
		1.6TC	59.8 (2.354)	160.3 (6.311)	200.5 (7.894)
2SP...19	+ 1SPA	9.8TC	57.3 (2.256)	171.3 (6.742)	227.4 (8.953)
		7.8TC	57.3 (2.256)	167.3 (6.587)	219.5 (8.642)
		6.3TC	57.3 (2.256)	164.5 (6.474)	213.8 (8.417)
		5.0TC	57.3 (2.256)	161.9 (6.374)	208.7 (8.217)
		4.2TC	57.3 (2.256)	160.4 (6.313)	205.6 (8.094)
		3.7TC	57.3 (2.256)	159.4 (6.276)	203.7 (8.020)
		3.2TC	57.3 (2.256)	158.4 (6.236)	201.7 (7.941)
		2.5TC	57.3 (2.256)	157.1 (6.183)	199.0 (7.835)
		2.0TC	57.3 (2.256)	156.1 (6.144)	197.0 (7.756)
		1.6TC	57.3 (2.256)	155.3 (6.114)	195.5 (7.697)
2SP...16	+ 1SPA	9.8TC	54.8 (2.157)	166.3 (6.545)	222.4 (8.756)
		7.8TC	54.8 (2.157)	162.3 (6.390)	214.5 (8.445)
		6.3TC	54.8 (2.157)	159.5 (6.278)	208.8 (8.220)
		5.0TC	54.8 (2.157)	156.9 (6.177)	203.7 (8.020)
		4.2TC	54.8 (2.157)	155.4 (6.116)	200.6 (7.898)
		3.7TC	54.8 (2.157)	154.4 (6.079)	198.7 (7.823)
		3.2TC	54.8 (2.157)	153.4 (6.039)	196.7 (7.744)
		2.5TC	54.8 (2.157)	152.1 (5.986)	194.0 (7.638)
		2.0TC	54.8 (2.157)	151.1 (5.947)	192.0 (7.559)
		1.6TC	54.8 (2.157)	150.3 (5.917)	190.5 (7.500)

Codice ordinazione kit / kit order code **010921010000000**

 Codice ordinazione kit / kit order code **010921010000000**

		mm (inch)			
		A	B	C	
2SP...14	+ 1SPA	9.8TC	52.7 (2.075)	162.1 (6.380)	218.2 (8.591)
		7.8TC	52.7 (2.075)	158.1 (6.224)	210.3 (8.280)
		6.3TC	52.7 (2.075)	155.3 (6.112)	204.6 (8.055)
		5.0TC	52.7 (2.075)	152.7 (6.012v)	199.5 (7.854)
		4.2TC	52.7 (2.075)	151.2 (5.951)	196.4 (7.732)
		3.7TC	52.7 (2.075)	150.2 (5.913)	194.5 (7.657)
		3.2TC	52.7 (2.075)	149.2 (5.874)	192.5 (7.579)
		2.5TC	52.7 (2.075)	147.9 (5.821)	189.8 (7.472)
		2.0TC	52.7 (2.075)	146.9 (5.782)	187.8 (7.394)
		1.6TC	52.7 (2.075)	146.1 (5.752)	186.3 (7.335)
2SP...11	+ 1SPA	9.8TC	50.2 (1.976)	157.1 (6.183)	213.2 (8.394)
		7.8TC	50.2 (1.976)	153.1 (6.028)	205.3 (8.083)
		6.3TC	50.2 (1.976)	150.3 (5.915)	199.6 (7.858)
		5.0TC	50.2 (1.976)	147.7 (5.815)	194.5 (7.657)
		4.2TC	50.2 (1.976)	146.2 (5.754)	191.4 (7.535)
		3.7TC	50.2 (1.976)	145.2 (5.717)	189.5 (7.461)
		3.2TC	50.2 (1.976)	144.2 (5.677)	187.5 (7.382)
		2.5TC	50.2 (1.976)	142.9 (5.624)	184.8 (7.276)
		2.0TC	50.2 (1.976)	141.9 (5.585)	182.8 (7.197)
		1.6TC	50.2 (1.976)	141.1 (5.555)	181.3 (7.138)
2SP...8	+ 1SPA	9.8TC	48.2 (1.896)	152.9 (6.022)	209.1 (8.232)
		7.8TC	48.2 (1.896)	149.0 (5.866)	201.2 (7.921)
		6.3TC	48.2 (1.896)	146.2 (5.754)	195.5 (7.697)
		5.0TC	48.2 (1.896)	143.6 (5.654)	190.4 (7.496)
		4.2TC	48.2 (1.896)	142.1 (5.593)	187.3 (7.374)
		3.7TC	48.2 (1.896)	141.1 (5.555)	185.4 (7.299)

		mm (inch)			
		A	B	C	
2SP...8	+ 1SPA	3.2TC	48.2 (1.896)	140.1 (5.516)	183.4 (7.220)
		2.5TC	48.2 (1.896)	138.8 (5.463)	180.7 (7.114)
		2.0TC	48.2 (1.896)	137.8 (5.423)	178.7 (7.035)
		1.6TC	48.2 (1.896)	137.0 (5.394)	177.2 (6.976)
		1.2TC	48.2 (1.896)	136.2 (5.360)	175.5 (6.909)
		0.9TC	48.2 (1.896)	135.6 (5.339)	174.4 (6.866)
		9.8TC	46.1 (1.813)	148.8 (5.856)	204.9 (8.067)
		7.8TC	46.1 (1.813)	144.8 (5.701)	197.0 (7.756)
		6.3TC	46.1 (1.813)	141.9 (5.589)	191.3 (7.532)
		5.0TC	46.1 (1.813)	139.4 (5.488)	186.2 (7.331)
2SP...6	+ 1SPA	4.2TC	46.1 (1.813)	137.9 (5.427)	183.1 (7.209)
		3.7TC	46.1 (1.813)	136.9 (5.390)	181.2 (7.134)
		3.2TC	46.1 (1.813)	135.9 (5.350)	179.2 (7.055)
		2.5TC	46.1 (1.813)	134.6 (5.297)	176.5 (6.949)
		2.0TC	46.1 (1.813)	133.6 (5.258)	174.5 (6.870)
		1.6TC	46.1 (1.813)	132.8 (5.228)	173.0 (6.811)
		1.2TC	46.1 (1.813)	131.9 (5.195)	171.3 (6.744)
		0.9TC	46.1 (1.813)	131.4 (5.173)	170.2 (6.701)
		9.8TC	44.4 (1.748)	145.5 (5.726)	201.6 (7.937)
		7.8TC	44.4 (1.748)	141.5 (5.571)	193.7 (7.626)
2SP...4	+ 1SPA	6.3TC	44.4 (1.748)	138.7 (5.459)	188.0 (7.402)
		5.0TC	44.4 (1.748)	136.1 (5.358)	182.9 (7.201)
		4.2TC	44.4 (1.748)	134.6 (5.297)	179.8 (7.079)
		3.7TC	44.4 (1.748)	133.6 (5.260)	177.9 (7.004)
		3.2TC	44.4 (1.748)	132.6 (5.220)	175.9 (6.925)
		2.5TC	44.4 (1.748)	131.3 (5.167)	173.2 (6.819)
		2.0TC	44.4 (1.748)	130.3 (5.128)	171.2 (6.740)
		1.6TC	44.4 (1.748)	129.5 (5.098)	169.7 (6.681)
		1.2TC	44.4 (1.748)	128.7 (5.065)	168.0 (6.614)
		0.9TC	44.4 (1.748)	128.1 (5.043)	166.9 (6.571)

Con la flangia B80C incrementare le quote A, B e C di 2 mm
 Con la flangia E52C diminuire le quote A, B e C di 2.7 mm

With B80C flange increase A, B, and C dimensions of 0.079 inch
 With E52C flange decrease A, B, and C dimensions of 0.106 inch

GR 2 + GR 2

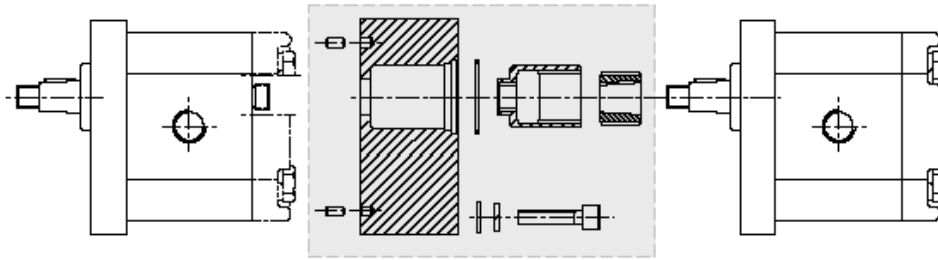

Codice ordinazione kit / kit order code **01092200000000**

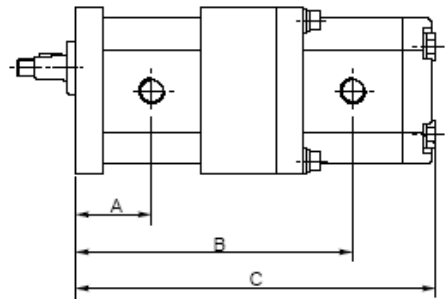

Codice ordinazione kit / kit order code **01092200000000**

				mm (inch)		
				A	B	C
2SP ...4	+ 2SP ...	4		44.4	166.2	214.8
				(1.748)	(6.543)	(8.457)
2SP ...6	+ 2SP ...	6		46.0	171.2	221.4
				(1.811)	(6.740)	(8.717)
		4		46.0	169.5	218.1
				(1.811)	(6.673)	(8.587)
2SP ...8	+ 2SP ...	8		48.1	177.5	229.8
				(1.894)	(6.988)	(9.047)
		6		48.1	175.4	225.6
				(1.894)	(6.906)	(8.882)
4		48.1	173.7	222.3		
		(1.894)	(6.839)	(8.752)		

Codice ordinazione kit / kit order code **01092200000000**

				mm (inch)		
				A	B	C
2SP ...11	+ 2SP ...	11		50.2	183.6	238.0
				(1.976)	(7.228)	(9.370)
		8		50.2	181.6	233.9
				(1.976)	(7.150)	(9.209)
2SP ...14	+ 2SP ...	6		50.2	179.5	229.7
				(1.976)	(7.067)	(9.043)
		4		50.2	177.8	226.4
				(1.976)	(7.000)	(8.913)
2SP ...14	+ 2SP ...	14		52.7	191.1	248.0
				(2.075)	(7.524)	(9.764)
		11		52.7	188.6	243.0
				(2.075)	(7.425)	(9.567)
2SP ...14	+ 2SP ...	8		52.7	186.6	238.9
				(2.075)	(7.346)	(9.406)
		6		52.7	184.5	234.7
				(2.075)	(7.264)	(9.240)
4		52.7	182.8	231.4		
		(2.075)	(7.197)	(9.110)		

Codice ordinazione kit / kit order code **01092200000000**

mm (inch)

		A	B	C
2SP ...16 + 2SP ...	16	54.8 (2.157)	197.4 (7.772)	256.4 (10.094)
	14	54.8 (2.157)	195.3 (7.689)	252.2 (9.929)
	11	54.8 (2.157)	192.8 (7.591)	247.2 (9.732)
	8	54.8 (2.157)	190.8 (7.512)	243.1 (9.571)
	6	54.8 (2.157)	188.7 (7.429)	238.9 (9.406)
	4	54.8 (2.157)	187.0 (7.362)	235.6 (9.276)
2SP ...19 + 2SP ...	19	57.3 (2.256)	204.9 (8.067)	266.4 (10.488)
	16	57.3 (2.256)	202.4 (7.969)	261.4 (10.291)
	14	57.3 (2.256)	200.3 (7.886)	257.2 (10.126)
	11	57.3 (2.256)	197.8 (7.787)	252.2 (9.929)
	8	57.3 (2.256)	195.8 (7.709)	248.1 (9.768)
	6	57.3 (2.256)	193.7 (7.626)	243.9 (9.602)
2SP ...22 + 2SP ...	22	59.8 (2.354)	212.4 (8.362)	276.4 (10.882)
	19	59.8 (2.354)	209.9 (8.264)	271.4 (10.685)
	16	59.8 (2.354)	207.4 (8.165)	266.4 (10.488)
	14	59.8 (2.354)	205.3 (8.083)	262.2 (10.323)
	11	59.8 (2.354)	202.8 (7.984)	257.2 (10.126)
	8	59.8 (2.354)	200.8 (7.906)	253.1 (9.965)
	6	59.8 (2.354)	198.7 (7.823)	248.9 (9.799)
	4	59.8 (2.354)	197.0 (7.756)	245.6 (9.669)

Codice ordinazione kit / kit order code **01092200000000**

mm (inch)

		A	B	C
2SP ...26 + 2SP ...	26	62.7 (2.469)	221.1 (8.705)	288.0 (11.339)
	22	62.7 (2.469)	218.2 (8.591)	282.2 (11.110)
	19	62.7 (2.469)	215.7 (8.492)	277.2 (10.913)
	16	62.7 (2.469)	213.2 (8.394)	272.2 (10.717)
	14	62.7 (2.469)	211.1 (8.311)	268.0 (10.551)
	11	62.7 (2.469)	208.6 (8.213)	263.0 (10.354)
2SP ...26 + 2SP ...	8	62.7 (2.469)	206.6 (8.134)	258.9 (10.193)
	6	62.7 (2.469)	204.5 (8.051)	254.7 (10.028)
	4	62.7 (2.469)	202.8 (7.984)	251.4 (9.898)

GR 2 + GR 2 TC

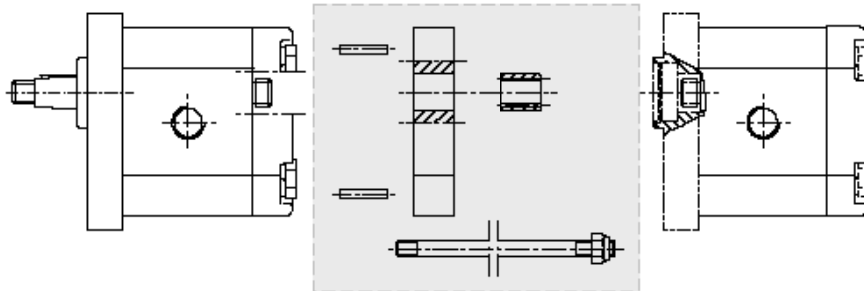

Codice ordinazione kit / kit order code

Il Kit standard viene fornito con tiranti e dadi autobloccanti (max. ingombro C); se le pompe tandem sono fornite già assemblate, l'ingombro C è leggermente inferiore in quanto vengono utilizzate viti TCEI (consultare il ns. servizio tecnico per avere gli ingombri esatti).

The standard Kit is supplied with tension rods and self-locking nuts (max. dimension C); if the tandem pumps are supplied already assembled, the external dimensions of C are slightly less because socket-head screws are used (contact our technical service for the exact dimensions).

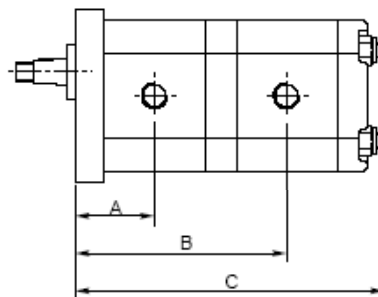

		mm (inch)		
		A	B	C
2SP ...4	+ 2SP ...	4	44.4 (1.748)	116.2 (4.575)
		6	46.0 (1.811)	121.2 (4.772)
2SP ...6	+ 2SP ...	4	46.0 (1.811)	119.5 (4.705)
		8	48.1 (1.894)	127.5 (5.020)
2SP ...8	+ 2SP ...	6	48.1 (1.894)	125.5 (4.941)
		4	48.1 (1.894)	123.7 (4.870)
2SP ...11	+ 2SP ...	11	50.2 (1.976)	133.6 (5.260)
		8	50.2 (1.976)	131.6 (5.181)
		6	50.2 (1.976)	129.5 (5.098)
2SP ...	4	50.2 (1.976)	127.8 (5.032)	

		mm (inch)		
		A	B	C
2SP ...	+ 2SP ...	14	52.7 (2.075)	141.1 (5.555)
		11	52.7 (2.075)	138.6 (5.457)
2SP ...14	+ 2SP ...	8	52.7 (2.075)	136.6 (5.378)
		6	52.7 (2.075)	134.5 (5.295)
		4	52.7 (2.075)	132.8 (5.228)
2SP ...	+ 2SP ...	16	54.8 (2.157)	147.4 (5.803)
		14	54.8 (2.157)	145.3 (5.720)
2SP ...16	+ 2SP ...	11	54.8 (2.157)	142.8 (5.622)
		8	54.8 (2.157)	140.8 (5.543)
		6	54.8 (2.157)	138.7 (5.461)
2SP ...	4	54.8 (2.157)	137 (5.394)	

		mm (inch)		
		A	B	C
		Codice ordinazione kit / kit order code 010922291890500		
2SP ...	19	57.3 (2.256)	153.9 (6.059)	232 (9.134)
		Codice ordinazione kit / kit order code 010922291890400		
2SP ...	16	57.3 (2.256)	152.4 (6.000)	219 (8.622)
	14	57.3 (2.256)	150.3 (5.917)	219 (8.622)
2SP ...19 +	Codice ordinazione kit / kit order code 010922291890300			
	11	57.3 (2.256)	147.8 (5.819)	208 (8.189)
2SP ...	8	57.3 (2.256)	145.8 (5.740)	208 (8.189)
	6	57.3 (2.256)	143.7 (5.657)	208 (8.189)
		Codice ordinazione kit / kit order code 010922291890200		
2SP ...	4	57.3 (2.256)	142 (5.591)	192 (7.559)
		Codice ordinazione kit / kit order code 010922291890500		
2SP ...	22	59.8 (2.354)	162.4 (6.394)	232 (9.134)
	19	59.8 (2.354)	159.9 (6.295)	232 (9.134)
	16	59.8 (2.354)	157.4 (6.197)	232 (9.134)
		Codice ordinazione kit / kit order code 010922291890400		
2SP ...22 +	14	59.8 (2.354)	155.3 (6.114)	219 (8.622)
2SP ...	11	59.8 (2.354)	152.8 (6.016)	219 (8.622)
		Codice ordinazione kit / kit order code 010922291890300		
2SP ...	8	59.8 (2.354)	150.8 (5.937)	208 (8.189)
	6	59.8 (2.354)	148.7 (5.854)	208 (8.189)
	4	59.8 (2.354)	147 (5.787)	208 (8.189)

		mm (inch)		
		A	B	C
		Codice ordinazione kit / kit order code 010922291890600		
2SP ...	26	62.7 (2.469)	171.1 (6.736)	244 (9.606)
	22	62.7 (2.469)	168.2 (6.622)	244 (9.606)
		Codice ordinazione kit / kit order code 010922291890500		
2SP ...	19	62.7 (2.469)	165.7 (6.524)	232 (9.134)
	16	62.7 (2.469)	163.2 (6.425)	232 (9.134)
2SP ...26 +	14	62.7 (2.469)	161.1 (6.343)	232 (9.134)
		Codice ordinazione kit / kit order code 010922291890400		
2SP ...	11	62.7 (2.469)	158.6 (6.244)	219 (8.622)
	8	62.7 (2.469)	156.6 (6.165)	219 (8.622)
	6	62.7 (2.469)	154.5 (6.083)	219 (8.622)
		Codice ordinazione kit / kit order code 010922291890300		
2SP ...	4	62.7 (2.469)	152.8 (6.016)	208 (8.189)

GR 3 + GR 1

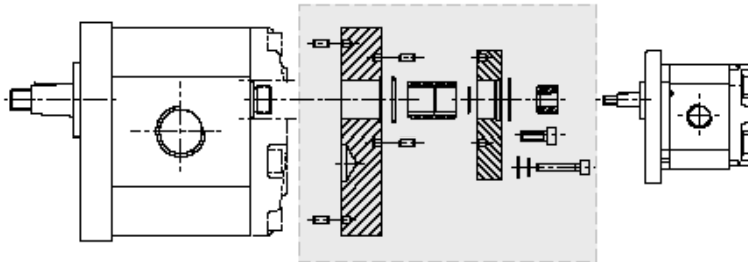

Codice ordinazione kit / kit order code **01093110000000**

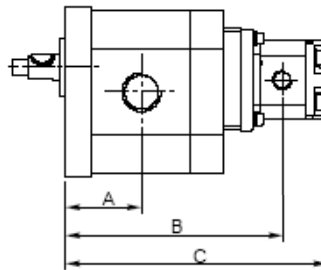

Codice ordinazione kit / kit order code **01093110000000**

		mm (inch)		
		A	B	C
3SP...62 + 1SPA	9.8	80.4 (3.163)	234.9 (9.250)	291.1 (11.461)
	7.8	80.4 (3.163)	231.0 (9.094)	283.2 (11.150)
	6.3	80.4 (3.163)	228.2 (8.982)	277.5 (10.925)
	5	80.4 (3.163)	225.6 (8.882)	272.4 (10.724)
	4.2	80.4 (3.163)	224.1 (8.821)	269.3 (10.602)
	3.7	80.4 (3.163)	223.1 (8.783)	267.4 (10.528)
	3.2	80.4 (3.163)	222.1 (8.744)	265.4 (10.449)
	2.5	80.4 (3.163)	220.8 (8.691)	262.7 (10.343)
	2	80.4 (3.163)	219.8 (8.652)	260.7 (10.264)
	1.6	80.4 (3.163)	219.0 (8.622)	259.2 (10.205)
	1.2	80.4 (3.163)	218.2 (8.589)	257.5 (10.138)
	0.9	80.4 (3.163)	217.6 (8.567)	256.4 (10.094)

Codice ordinazione kit / kit order code **01093110000000**

		mm (inch)		
		A	B	C
3SP...52 + 1SPA	9.8	76.4 (3.006)	226.9 (8.935)	283.1 (11.146)
	7.8	76.4 (3.006)	223.0 (8.780)	275.2 (10.835)
	6.3	76.4 (3.006)	220.2 (8.667)	269.5 (10.610)
	5	76.4 (3.006)	217.6 (8.567)	264.4 (10.409)
	4.2	76.4 (3.006)	216.1 (8.506)	261.3 (10.287)
	3.7	76.4 (3.006)	215.1 (8.469)	259.4 (10.213)
	3.2	76.4 (3.006)	214.1 (8.429)	257.4 (10.134)
	2.5	76.4 (3.006)	212.8 (8.376)	254.7 (10.028)
	2	76.4 (3.006)	211.8 (8.337)	252.7 (9.949)
	1.6	76.4 (3.006)	211.0 (8.307)	251.2 (9.890)
	1.2	76.4 (3.006)	210.2 (8.274)	249.5 (9.823)
	0.9	76.4 (3.006)	209.6 (8.252)	248.4 (9.780)

Con la flangia SAE B incrementare le quote A, B e C di 3 mm

With SAE B flange increase A, B, and C dimensions of 0.118 inch



B-20

Codice ordinazione kit / kit order code **01093110000000**

		mm (inch)					
		A	B	C			
3SP...44	+ 1SPA	9.8	72.9 (2.868)	219.9 (8.659)	276.1 (10.870)		
		7.8	72.9 (2.868)	216.0 (8.504)	268.2 (10.559)		
		6.3	72.9 (2.868)	213.2 (8.392)	262.5 (10.335)		
		5	72.9 (2.868)	210.6 (8.291)	257.4 (10.134)		
		4.2	72.9 (2.868)	209.1 (8.230)	254.3 (10.012)		
		3.7	72.9 (2.868)	208.1 (8.193)	252.4 (9.937)		
		3.2	72.9 (2.868)	207.1 (8.154)	250.4 (9.858)		
		2.5	72.9 (2.868)	205.8 (8.100)	247.7 (9.752)		
		2	72.9 (2.868)	204.8 (8.061)	245.7 (9.673)		
		1.6	72.9 (2.868)	204.0 (8.032)	244.2 (9.614)		
		1.2	72.9 (2.868)	203.2 (7.998)	242.5 (9.547)		
		0.9	72.9 (2.868)	202.6 (7.976)	241.4 (9.504)		
		3SP...36	+ 1SPA	9.8	69.9 (2.750)	213.9 (8.423)	270.1 (10.634)
				7.8	68.4 (2.691)	210.0 (8.268)	262.2 (10.323)
6.3	69.9 (2.750)			207.2 (8.156)	256.5 (10.098)		
5	69.9 (2.750)			204.6 (8.055)	251.4 (9.898)		
4.2	69.9 (2.750)			203.1 (7.994)	248.3 (9.776)		
3.7	69.9 (2.750)			202.1 (7.957)	246.4 (9.701)		
3.2	69.9 (2.750)			201.1 (7.917)	244.4 (9.622)		
2.5	69.9 (2.750)			199.8 (7.864)	241.7 (9.516)		
2	69.9 (2.750)			198.8 (7.825)	239.7 (9.437)		
1.6	69.9 (2.750)			198.0 (7.795)	238.2 (9.378)		
1.2	69.9 (2.750)			197.2 (7.762)	236.5 (9.311)		
0.9	69.9 (2.750)			196.60 (7.740)	235.4 (9.268)		
3SP...33	+ 1SPA			9.8	68.4 (2.691)	210.9 (8.305)	267.1 (10.516)
				7.8	68.4 (2.691)	207.0 (8.150)	259.2 (10.205)
		6.3	68.4 (2.691)	204.2 (8.037)	253.5 (9.980)		
		5	68.4 (2.691)	201.6 (7.937)	248.4 (9.780)		
		4.2	68.4 (2.691)	200.4 (7.876)	245.3 (9.657)		
		3.7	68.4 (2.691)	199.1 (7.839)	243.4 (9.583)		
		3.2	68.4 (2.691)	198.1 (7.799)	241.4 (9.504)		
		2.5	68.4 (2.691)	196.8 (7.746)	238.7 (9.398)		
		2	68.4 (2.691)	195.8 (7.707)	236.7 (9.319)		
		1.6	68.4 (2.691)	195.0 (7.677)	235.2 (9.260)		
		1.2	68.4 (2.691)	194.2 (7.644)	233.5 (9.193)		
		0.9	68.4 (2.691)	193.6 (7.622)	232.4 (9.150)		

Codice ordinazione kit / kit order code **01093110000000**

		mm (inch)					
		A	B	C			
3SP...29	+ 1SPA	9.8	66.9 (2.632)	207.9 (8.187)	264.1 (10.398)		
		7.8	66.9 (2.632)	204.0 (8.032)	256.2 (10.087)		
		6.3	66.9 (2.632)	201.2 (7.919)	250.5 (9.862)		
		5	66.9 (2.632)	198.6 (7.819)	245.4 (9.661)		
		4.2	66.9 (2.632)	197.1 (7.758)	242.3 (9.539)		
		3.7	66.9 (2.632)	196.1 (7.720)	240.4 (9.465)		
		3.2	66.9 (2.632)	195.1 (7.681)	238.4 (9.386)		
		2.5	66.9 (2.632)	193.8 (7.628)	235.7 (9.280)		
		2	66.9 (2.632)	192.8 (7.589)	233.7 (9.201)		
		1.6	66.9 (2.632)	192.0 (7.559)	232.2 (9.142)		
		1.2	66.9 (2.632)	191.2 (7.526)	230.5 (9.075)		
		0.9	66.9 (2.632)	190.6 (7.504)	229.4 (9.032)		
		3SP...22	+ 1SPA	9.8	63.9 (2.514)	201.9 (7.951)	258.1 (10.161)
				7.8	63.9 (2.514)	198.0 (7.795)	250.2 (9.850)
6.3	63.9 (2.514)			195.2 (7.683)	244.5 (9.626)		
5	63.9 (2.514)			192.6 (7.583)	239.4 (9.425)		
4.2	63.9 (2.514)			191.1 (7.522)	236.3 (9.303)		
3.7	63.9 (2.514)			190.1 (7.484)	234.4 (9.228)		
3.2	63.9 (2.514)			189.1 (7.445)	232.4 (9.150)		
2.5	63.9 (2.514)			187.8 (7.392)	229.7 (9.043)		
2	63.9 (2.514)			186.8 (7.352)	227.7 (8.965)		
1.6	63.9 (2.514)			186.0 (7.323)	226.2 (8.906)		
1.2	63.9 (2.514)			185.2 (7.289)	224.5 (8.839)		
0.9	63.9 (2.514)			184.6 (7.268)	223.4 (8.795)		
3SP...19	+ 1SPA			9.8	62.4 (2.455)	198.9 (7.833)	255.1 (10.043)
				7.8	62.4 (2.455)	195.0 (7.677)	247.2 (9.732)
		6.3	62.4 (2.455)	192.2 (7.565)	241.5 (9.508)		
		5	62.4 (2.455)	189.6 (7.465)	236.4 (9.307)		
		4.2	62.4 (2.455)	188.1 (7.404)	233.3 (9.185)		
		3.7	62.4 (2.455)	187.1 (7.366)	231.4 (9.110)		
		3.2	62.4 (2.455)	186.1 (7.327)	229.4 (9.032)		
		2.5	62.4 (2.455)	184.8 (7.274)	226.7 (8.925)		
		2	62.4 (2.455)	183.8 (7.234)	224.7 (8.846)		
		1.6	62.4 (2.455)	183.0 (7.205)	223.2 (8.787)		
		1.2	62.4 (2.455)	182.2 (7.171)	221.5 (8.720)		
		0.9	62.4 (2.455)	181.6 (7.150)	220.4 (8.677)		

GR 3 + GR 1 TC

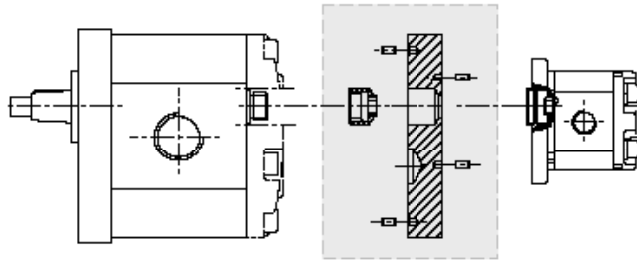

Codice ordinazione kit / kit order code **01093101000000**

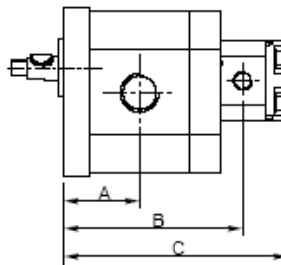

Codice ordinazione kit / kit order code **01093101000000**

		mm (inch)		
		A	B	C
3SP...62 + 1SPA	9.8TC	80.4 (3.163)	198.7 (7.821)	254.8 (10.032)
	7.8TC	80.4 (3.163)	194.7 (7.665)	246.9 (9.720)
	6.3TC	80.4 (3.163)	191.9 (7.553)	241.2 (9.496)
	5.0TC	80.4 (3.163)	189.3 (7.453)	236.1 (9.295)
	4.2TC	80.4 (3.163)	187.8 (7.392)	233.0 (9.173)
	3.7TC	80.4 (3.163)	186.8 (7.354)	231.1 (9.098)
	3.2TC	80.4 (3.163)	185.8 (7.315)	229.1 (9.020)
	2.5TC	80.4 (3.163)	184.5 (7.262)	226.4 (8.913)
	2.0TC	80.4 (3.163)	183.5 (7.222)	224.4 (8.835)
	1.6TC	80.4 (3.163)	182.7 (7.193)	222.9 (8.776)
	1.2TC	80.4 (3.163)	181.9 (7.159)	221.2 (8.709)
	0.9TC	80.4 (3.163)	181.3 (7.138)	220.1 (8.665)

Con la flangia SAE B incrementare le quote A, B e C di 3 mm

Codice ordinazione kit / kit order code **01093101000000**

		mm (inch)		
		A	B	C
3SP...52 + 1SPA	9.8TC	76.4 (3.006)	190.7 (7.506)	246.8 (9.717)
	7.8TC	76.4 (3.006)	186.7 (7.350)	238.9 (9.406)
	6.3TC	76.4 (3.006)	183.9 (7.238)	233.2 (9.181)
	5.0TC	76.4 (3.006)	181.3 (7.138)	228.1 (8.980)
	4.2TC	76.4 (3.006)	179.8 (7.077)	225.0 (8.858)
	3.7TC	76.4 (3.006)	178.8 (7.039)	223.1 (8.783)
	3.2TC	76.4 (3.006)	177.8 (7.000)	221.1 (8.705)
	2.5TC	76.4 (3.006)	176.5 (6.947)	218.4 (8.598)
	2.0TC	76.4 (3.006)	175.5 (6.907)	216.4 (8.520)
	1.6TC	76.4 (3.006)	174.7 (6.878)	214.9 (8.461)
	1.2TC	76.4 (3.006)	173.9 (6.844)	213.2 (8.394)
	0.9TC	76.4 (3.006)	173.3 (6.823)	212.1 (8.350)

With SAE B flange increase A, B, and C dimensions of 0.118 inch

Codice ordinazione kit / Kit order code **01093101000000**Codice ordinazione kit / Kit order code **01093101000000**

		mm (inch)					
		A	B	C			
3SP...44	+ 1SPA	9.8TC	72.9 (2.868)	183.7 (7.230)	239.8 (9.441)		
		7.8TC	72.9 (2.868)	179.7 (7.075)	231.9 (9.130)		
		6.3TC	72.9 (2.868)	176.9 (6.963)	226.2 (8.906)		
		5.0TC	72.9 (2.868)	174.3 (6.862)	221.1 (8.705)		
		4.2TC	72.9 (2.868)	172.8 (6.801)	218.0 (8.583)		
		3.7TC	72.9 (2.868)	171.8 (6.764)	216.1 (8.508)		
		3.2TC	72.9 (2.868)	170.8 (6.724)	214.1 (8.429)		
		2.5TC	72.9 (2.868)	169.5 (6.671)	211.4 (8.323)		
		2.0TC	72.9 (2.868)	168.5 (6.632)	209.4 (8.244)		
		1.6TC	72.9 (2.868)	167.7 (6.602)	207.9 (8.185)		
		1.2TC	72.9 (2.868)	166.9 (6.569)	206.2 (8.118)		
		0.9TC	72.9 (2.868)	166.3 (6.547)	205.1 (8.075)		
		3SP...36	+ 1SPA	9.8TC	69.9 (2.750)	177.7 (6.994)	233.8 (9.205)
				7.8TC	69.9 (2.750)	173.7 (6.839)	225.9 (8.894)
				6.3TC	69.9 (2.750)	170.9 (6.726)	220.2 (8.669)
5.0TC	69.9 (2.750)			168.3 (6.626)	215.1 (8.469)		
4.2TC	69.9 (2.750)			166.8 (6.565)	212.0 (8.346)		
3.7TC	69.9 (2.750)			165.8 (6.528)	210.1 (8.272)		
3.2TC	69.9 (2.750)			164.8 (6.488)	208.1 (8.193)		
2.5TC	69.9 (2.750)			163.5 (6.435)	205.4 (8.087)		
2.0TC	69.9 (2.750)			162.5 (6.396)	203.4 (8.008)		
1.6TC	69.9 (2.750)			161.7 (6.366)	201.9 (7.949)		
1.2TC	69.9 (2.750)			160.9 (6.333)	200.2 (7.882)		
0.9TC	69.9 (2.750)			160.3 (6.311)	199.1 (7.839)		
3SP...33	+ 1SPA			9.8TC	68.4 (2.691)	174.7 (6.876)	230.8 (9.087)
				7.8TC	68.4 (2.691)	170.7 (6.720)	222.9 (8.776)
				6.3TC	68.4 (2.691)	167.9 (6.608)	217.2 (8.551)
		5.0TC	68.4 (2.691)	165.3 (6.508)	212.1 (8.350)		
		4.2TC	68.4 (2.691)	163.8 (6.447)	209.0 (8.228)		
		3.7TC	68.4 (2.691)	162.8 (6.409)	207.1 (8.154)		
		3.2TC	68.4 (2.691)	161.8 (6.370)	205.1 (8.075)		
		2.5TC	68.4 (2.691)	160.5 (6.317)	202.4 (7.969)		
		2.0TC	68.4 (2.691)	159.5 (6.278)	200.4 (7.890)		
		1.6TC	68.4 (2.691)	158.7 (6.248)	198.9 (7.831)		
		1.2TC	68.4 (2.691)	157.9 (6.215)	197.2 (7.764)		
		0.9TC	68.4 (2.691)	157.3 (6.193)	196.1 (7.720)		

		mm (inch)					
		A	B	C			
3SP...29	+ 1SPA	9.8TC	66.9 (2.632)	171.7 (6.758)	227.8 (8.969)		
		7.8TC	66.9 (2.632)	167.7 (6.602)	219.9 (8.657)		
		6.3TC	66.9 (2.632)	164.9 (6.490)	214.2 (8.433)		
		5.0TC	66.9 (2.632)	162.3 (6.390)	209.1 (8.232)		
		4.2TC	66.9 (2.632)	160.8 (6.329)	206.0 (8.110)		
		3.7TC	66.9 (2.632)	159.8 (6.291)	204.1 (8.035)		
		3.2TC	66.9 (2.632)	158.8 (6.252)	202.1 (7.957)		
		2.5TC	66.9 (2.632)	157.5 (6.199)	199.4 (7.850)		
		2.0TC	66.9 (2.632)	156.5 (6.159)	197.4 (7.772)		
		1.6TC	66.9 (2.632)	155.7 (6.130)	195.9 (7.713)		
		1.2TC	66.9 (2.632)	154.9 (6.096)	194.2 (7.646)		
		0.9TC	66.9 (2.632)	154.3 (6.075)	193.1 (7.602)		
		3SP...22	+ 1SPA	9.8TC	63.9 (2.514)	165.7 (6.522)	221.8 (8.732)
				7.8TC	63.9 (2.514)	161.7 (6.366)	213.9 (8.421)
				6.3TC	63.9 (2.514)	158.9 (6.254)	208.2 (8.197)
5.0TC	63.9 (2.514)			156.3 (6.154)	203.1 (7.996)		
4.2TC	63.9 (2.514)			154.8 (6.093)	200.0 (7.874)		
3.7TC	63.9 (2.514)			153.8 (6.055)	198.1 (7.799)		
3.2TC	63.9 (2.514)			152.8 (6.016)	196.1 (7.720)		
2.5TC	63.9 (2.514)			151.5 (5.963)	193.4 (7.614)		
2.0TC	63.9 (2.514)			150.5 (5.923)	191.4 (7.535)		
1.6TC	63.9 (2.514)			149.7 (5.894)	189.9 (7.476)		
1.2TC	63.9 (2.514)			148.9 (5.860)	188.2 (7.409)		
0.9TC	63.9 (2.514)			148.3 (5.839)	187.1 (7.366)		
3SP...19	+ 1SPA			9.8TC	62.4 (2.455)	162.7 (6.404)	218.8 (8.614)
				7.8TC	62.4 (2.455)	158.7 (6.248)	210.9 (8.303)
				6.3TC	62.4 (2.455)	155.9 (6.136)	205.2 (8.079)
		5.0TC	62.4 (2.455)	153.3 (6.035)	200.1 (7.878)		
		4.2TC	62.4 (2.455)	151.8 (5.974)	197.0 (7.756)		
		3.7TC	62.4 (2.455)	150.8 (5.937)	195.1 (7.681)		
		3.2TC	62.4 (2.455)	149.8 (5.898)	193.1 (7.602)		
		2.5TC	62.4 (2.455)	148.5 (5.844)	190.4 (7.496)		
		2.0TC	62.4 (2.455)	147.5 (5.805)	188.4 (7.417)		
		1.6TC	62.4 (2.455)	146.7 (5.776)	186.9 (7.358)		
		1.2TC	62.4 (2.455)	145.9 (5.742)	185.2 (7.291)		
		0.9TC	62.4 (2.455)	145.3 (5.720)	184.1 (7.248)		

GR 3 + GR 2

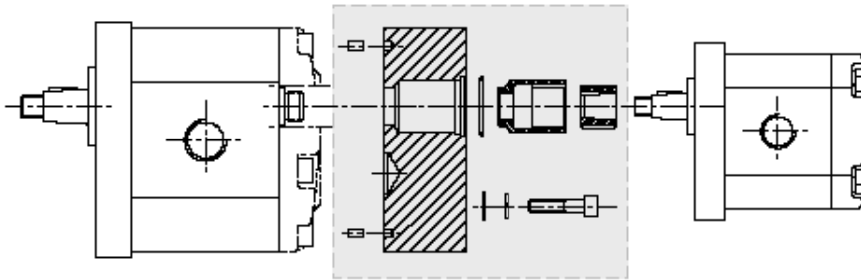

Codice ordinazione kit / kit order code **01093200000000**

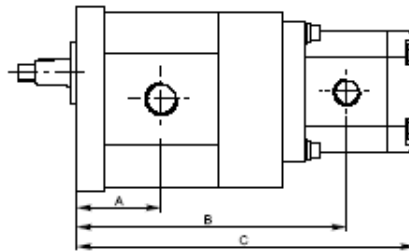

Codice ordinazione kit / kit order code **01093200000000**

		mm (inch)		
		A	B	C
3SP ...62 + 2SP	26	80.4 (3.165)	257.0 (10.118)	323.9 (12.752)
	22	80.4 (3.165)	254.1 (10.004)	318.1 (12.524)
	19	80.4 (3.165)	251.6 (9.906)	313.1 (12.327)
	16	80.4 (3.165)	249.1 (9.807)	308.1 (12.130)
	14	80.4 (3.165)	247.0 (9.724)	303.9 (11.965)
	11	80.4 (3.165)	244.5 (9.626)	298.9 (11.768)
	8	80.4 (3.165)	242.4 (9.543)	294.8 (11.606)
	6	80.4 (3.165)	240.3 (9.461)	290.6 (11.441)
	4	80.4 (3.165)	238.7 (9.398)	287.3 (11.311)

Codice ordinazione kit / kit order code **01093200000000**

		mm (inch)		
		A	B	C
3SP ...52 + 2SP	26	76.4 (3.008)	249.0 (9.803)	315.9 (12.437)
	22	76.4 (3.008)	246.1 (9.689)	310.1 (12.209)
	19	76.4 (3.008)	243.6 (9.591)	305.1 (12.012)
	16	76.4 (3.008)	241.1 (9.492)	300.1 (11.815)
	14	76.4 (3.008)	239.0 (9.409)	295.9 (11.650)
	11	76.4 (3.008)	236.5 (9.311)	290.9 (11.453)
	8	76.4 (3.008)	234.4 (9.228)	286.8 (11.291)
	6	76.4 (3.008)	232.3 (9.146)	282.6 (11.126)
	4	76.4 (3.008)	230.7 (9.083)	279.3 (10.996)



Codice ordinazione kit / kit order code **01093200000000**

		mm (inch)		
		A	B	C
3SP ...44 + 2SP	26	72.9 (2.870)	242.0 (9.528)	308.9 (12.161)
	22	72.9 (2.870)	239.1 (9.413)	303.1 (11.933)
	19	72.9 (2.870)	236.6 (9.315)	298.1 (11.736)
	16	72.9 (2.870)	234.1 (9.217)	293.1 (11.539)
	14	72.9 (2.870)	232.0 (9.134)	288.9 (11.374)
	11	72.9 (2.870)	229.5 (9.035)	283.9 (11.177)
	8	72.9 (2.870)	227.4 (8.953)	279.8 (11.016)
	6	72.9 (2.870)	225.3 (8.870)	275.6 (10.850)
	4	72.9 (2.870)	223.7 (8.807)	272.3 (10.720)
	3SP ...36 + 2SP	26	69.9 (2.752)	236.0 (9.291)
22		69.9 (2.752)	233.1 (9.177)	297.1 (11.697)
19		69.9 (2.752)	230.6 (9.079)	292.1 (11.500)
16		69.9 (2.752)	228.1 (8.980)	287.1 (11.303)
14		69.9 (2.752)	226.0 (8.898)	282.9 (11.138)
11		69.9 (2.752)	223.5 (8.799)	277.9 (10.941)
8		69.9 (2.752)	221.4 (8.717)	273.8 (10.780)
6		69.9 (2.752)	219.3 (8.634)	269.6 (10.614)
4		69.9 (2.752)	217.7 (8.571)	266.3 (10.484)
3SP ...33 + 2SP		26	68.4 (2.693)	232.0 (9.134)
	22	68.4 (2.693)	230.1 (9.059)	294.1 (11.579)
	19	68.4 (2.693)	227.6 (8.961)	289.1 (11.382)
	16	68.4 (2.693)	225.1 (8.862)	284.1 (11.185)
	14	68.4 (2.693)	223.0 (8.780)	279.9 (11.020)
	11	68.4 (2.693)	220.5 (8.681)	274.9 (10.823)
	8	68.4 (2.693)	218.4 (8.598)	270.8 (10.661)
	6	68.4 (2.693)	216.3 (8.516)	266.6 (10.496)
	4	68.4 (2.693)	214.7 (8.453)	263.3 (10.366)

Codice ordinazione kit / kit order code **01093200000000**

		mm (inch)		
		A	B	C
3SP ...29 + 2SP	26	66.9 (2.634)	230.0 (9.055)	296.9 (11.689)
	22	66.9 (2.634)	227.1 (8.941)	291.1 (11.461)
	19	66.9 (2.634)	224.6 (8.843)	286.1 (11.264)
	16	66.9 (2.634)	222.1 (8.744)	281.1 (11.067)
	14	66.9 (2.634)	220.0 (8.661)	276.9 (10.902)
	11	66.9 (2.634)	217.5 (8.563)	271.9 (10.705)
	8	66.9 (2.634)	215.4 (8.480)	267.8 (10.543)
	6	66.9 (2.634)	213.3 (8.398)	263.6 (10.378)
	4	66.9 (2.634)	201.7 (7.941)	260.3 (10.248)
	3SP ...22 + 2SP	26	63.9 (2.516)	224.0 (8.819)
22		63.9 (2.516)	221.1 (8.705)	285.1 (11.224)
19		63.9 (2.516)	218.6 (8.606)	280.1 (11.028)
16		63.9 (2.516)	216.1 (8.511)	275.1 (10.831)
14		63.9 (2.516)	214.0 (8.425)	270.9 (10.665)
11		63.9 (2.516)	211.5 (8.327)	265.9 (10.469)
8		63.9 (2.516)	209.4 (8.244)	261.8 (10.307)
6		63.9 (2.516)	207.3 (8.161)	257.6 (10.142)
4		63.9 (2.516)	205.7 (8.103)	254.3 (10.012)
3SP ...19 + 2SP		26	62.4 (2.457)	221.0 (8.701)
	22	62.4 (2.457)	218.1 (8.587)	282.1 (11.106)
	19	62.4 (2.457)	215.6 (8.488)	277.1 (10.909)
	16	62.4 (2.457)	213.1 (8.390)	272.1 (10.713)
	14	62.4 (2.457)	211.0 (8.307)	267.9 (10.547)
	11	62.4 (2.457)	208.5 (8.209)	262.9 (10.350)
	8	62.4 (2.457)	206.4 (8.126)	258.8 (10.189)
	6	62.4 (2.457)	204.3 (8.043)	254.6 (10.024)
	4	62.4 (2.457)	202.7 (7.980)	251.3 (9.894)

GR 3 + GR 2 TC

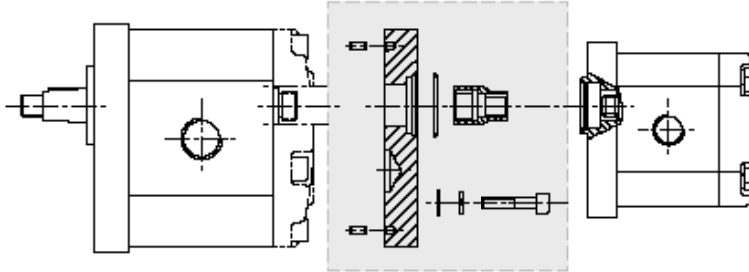

Codice ordinazione kit / kit order code **010932100000000**

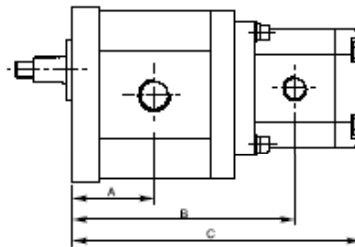

Codice ordinazione kit / kit order code **010932100000000**

		mm (inch)		
		A	B	C
3SP ...62 + 2SP	26	80.4 (3.165)	222.0 (8.740)	288.9 (11.374)
	22	80.4 (3.165)	219.1 (8.626)	283.1 (11.146)
	19	80.4 (3.165)	216.6 (8.528)	278.1 (10.949)
	16	80.4 (3.165)	214.1 (8.429)	273.1 (10.752)
	14	80.4 (3.165)	212.0 (8.346)	268.9 (10.587)
	11	80.4 (3.165)	209.5 (8.248)	263.9 (10.390)
	8	80.4 (3.165)	207.4 (8.165)	259.8 (10.228)
	6	80.4 (3.165)	205.3 (8.083)	255.6 (10.063)
	4	80.4 (3.165)	203.7 (8.020)	252.3 (9.933)

Codice ordinazione kit / kit order code **010932100000000**

		mm (inch)		
		A	B	C
3SP ...52 + 2SP	26	76.4 (3.008)	214.0 (8.425)	280.9 (11.059)
	22	76.4 (3.008)	211.1 (8.311)	275.1 (10.831)
	19	76.4 (3.008)	208.6 (8.213)	270.1 (10.634)
	16	76.4 (3.008)	206.1 (8.114)	265.1 (10.437)
	14	76.4 (3.008)	204.0 (8.032)	260.9 (10.272)
	11	76.4 (3.008)	201.5 (7.933)	255.9 (10.075)
	8	76.4 (3.008)	199.4 (7.850)	251.8 (9.913)
	6	76.4 (3.008)	197.3 (7.768)	247.6 (9.748)
	4	76.4 (3.008)	195.7 (7.705)	244.3 (9.618)

Codice ordinazione kit / kit order code **01093210000000**

 Codice ordinazione kit / kit order code **01093210000000**

		mm (inch)		
		A	B	C
3SP ...44 + 2SP	26	72.9 (2.870)	207.0 (8.150)	273.9 (10.783)
	22	72.9 (2.870)	204.1 (8.035)	268.1 (10.555)
	19	72.9 (2.870)	201.6 (7.937)	263.1 (10.358)
	16	72.9 (2.870)	199.1 (7.839)	258.1 (10.161)
	14	72.9 (2.870)	197.0 (7.756)	253.9 (9.996)
	11	72.9 (2.870)	194.5 (7.657)	248.9 (9.799)
	8	72.9 (2.870)	192.4 (7.575)	244.8 (9.638)
	6	72.9 (2.870)	190.3 (7.492)	240.6 (9.472)
	4	72.9 (2.870)	188.7 (7.429)	237.3 (9.343)
3SP ...36 + 2SP	26	69.9 (2.752)	201.0 (7.913)	267.9 (10.547)
	22	69.9 (2.752)	198.1 (7.799)	262.1 (10.319)
	19	69.9 (2.752)	195.6 (7.701)	257.1 (10.122)
	16	69.9 (2.752)	193.1 (7.602)	252.1 (9.925)
	14	69.9 (2.752)	191.0 (7.520)	247.9 (9.760)
	11	69.9 (2.752)	188.5 (7.421)	242.9 (9.563)
	8	69.9 (2.752)	186.4 (7.339)	238.8 (9.402)
	6	69.9 (2.752)	184.3 (7.256)	234.6 (9.236)
	4	69.9 (2.752)	182.7 (7.193)	231.3 (9.106)
3SP ...33 + 2SP	26	68.4 (2.693)	198.0 (7.795)	264.9 (10.429)
	22	68.4 (2.693)	195.1 (7.681)	259.1 (10.201)
	19	68.4 (2.693)	192.6 (7.583)	254.1 (10.004)
	16	68.4 (2.693)	190.1 (7.484)	249.1 (9.807)
	14	68.4 (2.693)	188.0 (7.402)	244.9 (9.642)
	11	68.4 (2.693)	185.5 (7.303)	239.9 (9.445)
	8	68.4 (2.693)	183.4 (7.220)	235.8 (9.283)
	6	68.4 (2.693)	181.3 (7.138)	231.6 (9.118)
	4	68.4 (2.693)	179.7 (7.075)	228.3 (8.988)

		mm (inch)		
		A	B	C
3SP ...29 + 2SP	26	66.9 (2.634)	195.0 (7.677)	261.9 (10.311)
	22	66.9 (2.634)	192.1 (7.563)	256.1 (10.083)
	19	66.9 (2.634)	189.6 (7.465)	251.1 (9.886)
	16	66.9 (2.634)	187.1 (7.366)	246.1 (9.689)
	14	66.9 (2.634)	185.0 (7.283)	241.9 (9.524)
	11	66.9 (2.634)	182.5 (7.185)	236.9 (9.327)
	8	66.9 (2.634)	180.4 (7.102)	232.8 (9.165)
	6	66.9 (2.634)	178.3 (7.020)	228.6 (9.000)
	4	66.9 (2.634)	176.7 (6.957)	225.3 (8.870)
3SP ...22 + 2SP	26	63.9 (2.516)	189.0 (7.441)	255.9 (10.075)
	22	63.9 (2.516)	186.1 (7.327)	250.1 (9.846)
	19	63.9 (2.516)	183.6 (7.228)	245.1 (9.650)
	16	63.9 (2.516)	181.1 (7.130)	240.1 (9.453)
	14	63.9 (2.516)	179.0 (7.047)	235.9 (9.287)
	11	63.9 (2.516)	176.5 (6.949)	230.9 (9.091)
	8	63.9 (2.516)	174.4 (6.866)	226.8 (8.929)
	6	63.9 (2.516)	172.3 (6.783)	222.6 (8.764)
	4	63.9 (2.516)	170.7 (6.720)	219.3 (8.634)
3SP ...19 + 2SP	26	62.4 (2.457)	186.0 (7.323)	252.9 (9.957)
	22	62.4 (2.457)	183.1 (7.209)	247.1 (9.728)
	19	62.4 (2.457)	180.6 (7.110)	242.1 (9.532)
	16	62.4 (2.457)	178.1 (7.012)	237.1 (9.335)
	14	62.4 (2.457)	176.0 (6.929)	232.9 (9.169)
	11	62.4 (2.457)	173.5 (6.831)	227.9 (8.972)
	8	62.4 (2.457)	171.4 (6.748)	223.8 (8.811)
	6	62.4 (2.457)	169.3 (6.665)	219.6 (8.646)
	4	62.4 (2.457)	167.7 (6.602)	216.3 (8.516)

GR 3 + GR 3

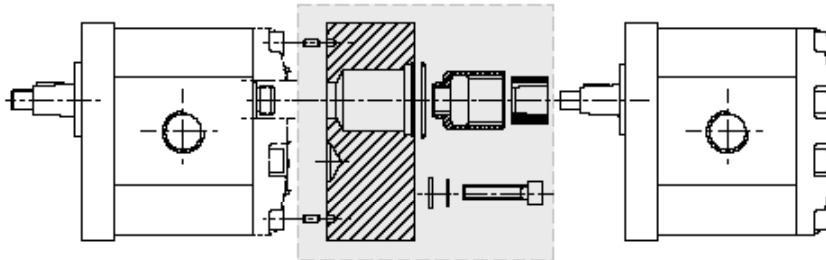

Codice ordinazione kit / kit order code **010933000000000**

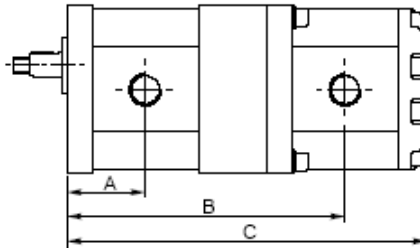

Codice ordinazione kit / kit order code **010933000000000**

Codice ordinazione kit / kit order code **010933000000000**

		mm (inch)		
		A	B	C
3SP 62	+ 3 SP ..			
		62	283.7	367.6
		(3.165)	(11.169)	(14.472)
		52	279.7	359.6
		(3.165)	(11.012)	(14.157)
		44	276.2	352.6
		(3.165)	(10.874)	(13.882)
		36	273.2	346.6
	(3.165)	(10.756)	(13.646)	
	33	272.7	343.6	
	(3.165)	(10.736)	(13.528)	
	29	270.2	340.6	
	(3.165)	(10.638)	(13.409)	
	22	267.2	334.6	
	(3.165)	(10.520)	(13.173)	
	19	265.7	331.6	
	(3.165)	(10.461)	(13.055)	
3SP 52	+ 3 SP ..			
		52	271.7	351.6
		(3.008)	(10.697)	(13.843)
		44	268.2	344.6
		(3.008)	(10.559)	(13.567)
		36	265.2	338.6
		(3.008)	(10.441)	(13.331)
		33	263.7	335.6
	(3.008)	(10.382)	(13.213)	
	29	262.2	332.6	
	(3.008)	(10.323)	(13.094)	
	22	259.2	326.6	
	(3.008)	(10.205)	(12.858)	
	19	257.7	323.6	
	(3.008)	(10.146)	(12.740)	
3SP 44	+ 3 SP ..			
		44	261.2	337.6
		(2.870)	(10.283)	(13.291)
		36	258.2	331.6
		(2.870)	(10.165)	(13.055)
		33	256.7	328.6
		(2.870)	(10.106)	(12.937)
		29	255.2	325.6
	(2.870)	(10.047)	(12.819)	
	22	252.2	319.6	
	(2.870)	(9.929)	(12.583)	
	19	250.7	316.6	
	(2.870)	(9.870)	(12.465)	

		mm (inch)		
		A	B	C
3SP 36	+ 3 SP ..			
		36	252.2	325.6
		(2.752)	(9.929)	(12.819)
		33	250.7	322.6
		(2.752)	(9.870)	(12.701)
		29	249.2	319.6
		(2.752)	(9.811)	(12.583)
		22	246.2	313.6
	(2.752)	(9.693)	(12.346)	
	19	244.7	310.6	
	(2.752)	(9.634)	(12.228)	
3SP 33	+ 3 SP ..			
		33	247.7	319.6
		(2.693)	(9.752)	(12.583)
		29	246.2	316.6
		(2.693)	(9.693)	(12.465)
		22	243.2	310.6
		(2.693)	(9.575)	(12.228)
		19	241.7	307.6
	(2.693)	(9.516)	(12.110)	
3SP 29	+ 3 SP ..			
		29	243.2	313.6
		(2.634)	(9.575)	(12.346)
		22	240.2	307.6
		(2.634)	(9.457)	(12.110)
		19	238.7	304.6
		(2.634)	(9.398)	(11.992)
		22	234.2	301.6
	(2.516)	(9.220)	(11.874)	
	19	232.7	298.6	
	(2.516)	(9.161)	(11.756)	
3SP 19	+ 3 SP ..			
		19	229.7	295.6
	(2.457)	(9.043)	(11.638)	



GR 3 + GR 3 TC

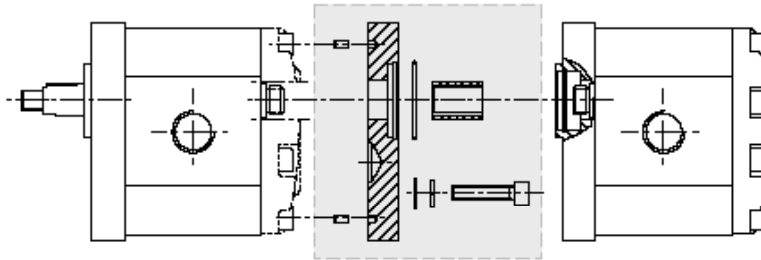

Codice ordinazione kit / kit order code **010933100000000**

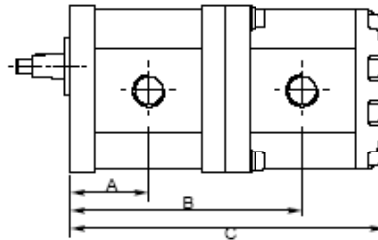

Codice ordinazione kit / kit order code **010933100000000**

Codice ordinazione kit / kit order code **010933100000000**

		mm (inch)					
		A	B	C			
3SP 62	+ 3 SP ..	62	80.4 (3.165)	239.7 (9.437)	323.6 (12.740)		
		52	80.4 (3.165)	235.7 (9.280)	315.6 (12.425)		
		44	80.4 (3.165)	232.2 (9.142)	308.6 (12.150)		
		36	80.4 (3.165)	229.2 (9.024)	302.6 (11.913)		
		33	80.4 (3.165)	227.7 (8.965)	299.6 (11.795)		
		29	80.4 (3.165)	226.2 (8.906)	296.6 (11.677)		
		22	80.4 (3.165)	223.2 (8.787)	290.6 (11.441)		
		19	80.4 (3.165)	221.7 (8.728)	287.6 (11.323)		
		3SP 52	+ 3 SP ..	52	76.4 (3.008)	227.7 (8.965)	307.6 (12.110)
44	76.4 (3.008)			224.2 (8.827)	300.6 (11.835)		
36	76.4 (3.008)			221.2 (8.709)	294.6 (11.598)		
33	76.4 (3.008)			219.7 (8.650)	291.6 (11.480)		
29	76.4 (3.008)			218.2 (8.591)	288.6 (11.362)		
22	76.4 (3.008)			215.2 (8.472)	282.6 (11.126)		
19	76.4 (3.008)			213.7 (8.413)	279.6 (11.008)		
3SP 44	+ 3 SP ..			44	72.9 (2.870)	217.2 (8.551)	293.6 (11.559)
				36	72.9 (2.870)	214.2 (8.433)	287.6 (11.323)
		33	72.9 (2.870)	212.7 (8.374)	284.6 (11.205)		
		29	72.9 (2.870)	211.2 (8.315)	281.6 (11.087)		
		22	72.9 (2.870)	208.2 (8.197)	275.6 (10.850)		
		19	72.9 (2.870)	206.7 (8.138)	272.6 (10.732)		

		mm (inch)					
		A	B	C			
3SP 36	+ 3 SP ..	36	69.9 (2.752)	208.2 (8.197)	281.6 (11.087)		
		33	69.9 (2.752)	206.7 (8.138)	278.6 (10.969)		
		29	69.9 (2.752)	205.2 (8.079)	275.6 (10.850)		
		22	69.9 (2.752)	202.2 (7.961)	269.6 (10.614)		
		19	69.9 (2.752)	200.7 (7.902)	266.6 (10.496)		
		3SP 33	+ 3 SP ..	33	68.4 (2.693)	203.7 (8.020)	275.6 (10.850)
29	68.4 (2.693)			202.2 (7.961)	272.6 (10.732)		
22	68.4 (2.693)			199.2 (7.843)	266.6 (10.496)		
19	68.4 (2.693)			197.7 (7.783)	263.6 (10.378)		
3SP 29	+ 3 SP ..			29	66.9 (2.634)	199.2 (7.843)	269.6 (10.614)
				22	66.9 (2.634)	196.2 (7.724)	263.6 (10.378)
		19	66.9 (2.634)	194.7 (7.665)	260.6 (10.260)		
3SP 22	+ 3 SP ..	22	63.9 (2.516)	190.2 (7.488)	257.6 (10.142)		
		19	63.9 (2.516)	188.7 (7.429)	254.6 (10.024)		
3SP 19	+ 3 SP ..	19	62.4 (2.457)	185.7 (7.311)	251.6 (9.906)		

GR 4 + GR 1

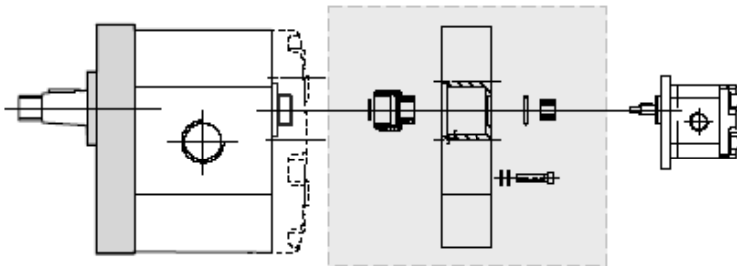

Codice ordinazione kit / kit order code 01041000000000

GR 4 + GR 2

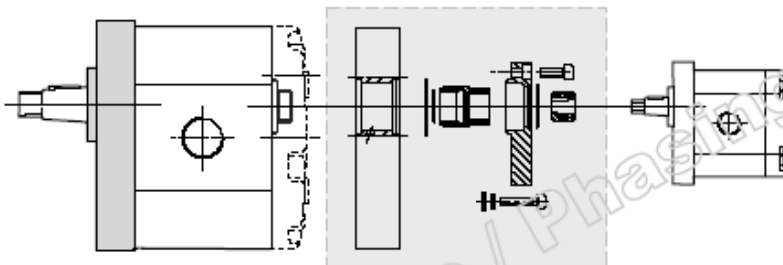

Codice ordinazione kit / kit order code 01042000000000

GR 4 + GR 3

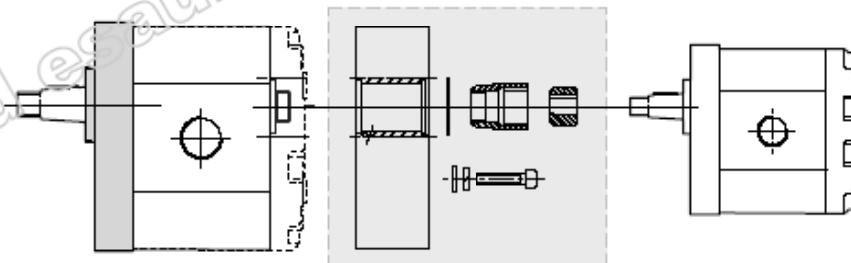

Codice ordinazione kit / kit order code 01043000000000

GR 4 + GR 4

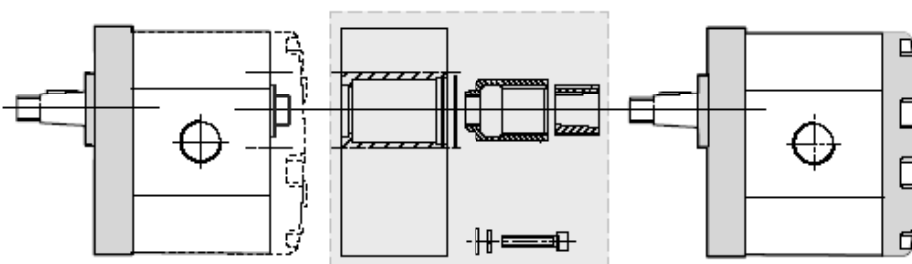

Codice ordinazione kit / kit order code 01044000000000

B-30

