



# PRESSURE CONTROL VALVES



# VVP. VALVES.

## PRESSURE CONTROL VALVES

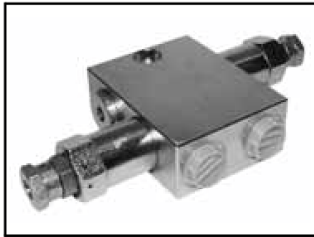

### DIRECT OPERATED VALVES

- Pressure relief valve VVP (NG 6, 10)
- Pressure relief valve VVB2-10 (NG 6)

5  
5  
9

Direct operated valves

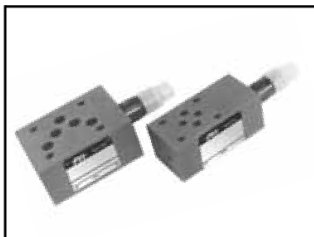

### PILOT OPERATED VALVES

- Pressure relief valve RT (NG 6, 10)
- Pressure relief valve VP-RT (NG 6, 10)

13  
13  
17

Pilot operated valves

## PRESSURE RELIEF VALVE VVP

- NG 6, 10
- Up to 400 bar [3,045 PSI]
- Up to 60 L/min [31.7 GPM]
- For fitting into a block.
- For independent mounting.
- Two pressure setting elements (set screw, rotary knob).



VVP-6, VVP-10

### Operation

These valves consist of a housing (1), a hardened seat (2), a poppet (3), with a damping spool (4), a spring (5), and a pressure setting element (6). The P-line of this pressure relief valve is connected with the hydraulic system. The pressure of the hydraulic fluid acts on the front side of the pilot poppet (3), and the force of the spring (5) set by the pressure setting element (6) is applied to the poppet from the opposite side. When the system pressure exceeds the valve of the spring set by the pressure setting element (6) the pilot poppet moves off the seat (2), and frees the flow of the hydraulic fluid in the direction from P towards T.

The damping spool (4) prevents vibrations of the pilot poppet when opening or closing the flow way of the hydraulic flow. Loosening of the pressure setting element is prevented by a counternut (8).

### Hydraulic symbol

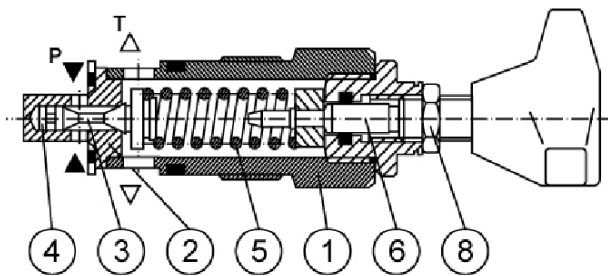
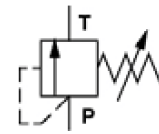

Direct operated pressure relief valves type VVP are used to maintain and limit the pressure in a hydraulic system.

### Features

Size		6	10
Flow rate	L/min [GPM]	50 [13.2]	120 [31.7]
Pressure setting range	bar [PSI]	400 [5 801]	
Oil temperature range	°C [°F]	-30 to +70 [-22 to + 158]	
Viscosity range	mm <sup>2</sup> /s [SUS]	2,8 to 380 [12.9 to 1760]	
Filtration	NAS 1638	8	
Mass	Execution A	0,4 [0.88]	0,5 [1.10]
	Execution B	0,5 [1.10]	0,6 [1.32]

**Dimensions**

Tightening torque for fixing:  
 Nominal size 6 Md=80 Nm [708 in.lbf].  
 Nominal size 10 Md=140 Nm [1 239 in.lbf].

Customer specified setting can be secured by means of a stamp and a wire.

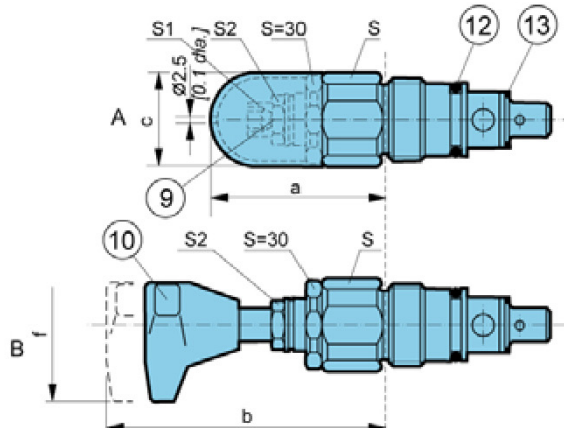
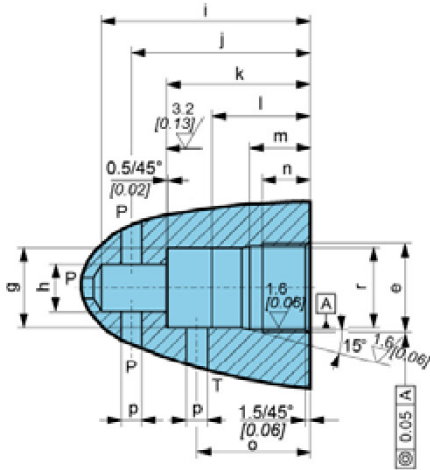

- 9. Pressure setting by screw and protective cap.
- 10. Pressure setting by rotary knob.
- 12. O-ring, nominal size 6, 19,2 x 3.
- O-ring, nominal size 10, 26 x 3.
- 13. Usit ring, nominal size 6, 17,4 x 24 x 1,5.
- Usit ring, nominal size 10, 24,7 x 31 x 2.

Type	a	b	Øc	e	Øf	Øg	Øh	i	j	k	l	m	n	o	Øp	Ør	s	s1	s2
VVP-6	72	94	34	M28x	60	24,9	15	65	56,5	45	30	19	15	35	6	25H9	32		
	[2.83]	[3.70]	[1.34]	1,5	[0.98]	[0.59]	[2.56]	[2.22]	[1.77]	[1.18]	[0.75]	[0.59]	[1.38]	[0.24]			[1.26]	6	19
VVP-10	68	90	38	M35x	60	31,9	18,5	80	67,5	52	35	23	18	41	10	32H9	36		
	[2.67]	[3.54]	[1.50]	1,5	[1.25]	[0.73]	[3.15]	[2.66]	[2.05]	[1.38]	[0.90]	[0.71]	[1.61]	[0.39]			[1.42]		

**Connecting dimensions / connection P-VVP-6, P-VVP-10**

When fitting, the excess ports for oil supply and discharge must be closed by means of suitable screw.

- 1. Oil discharge when fitted independently.
- 2. Oil supply when fitted independently.
- 3. Oil supply when fitted on a tank cover.
- 4. Oil discharge when fitted on a tank cover.

Size	Øa	Øb	c	d	Masse kg [lb]
6	59 d9	24	M18x1,5	60	2,5
	[2.32]	[0.94]		[2.36]	[5.51]
10	69 d9	28	M22x1,5	70	2,9
	[2.72]	[1.10]		[2.76]	[6.39]

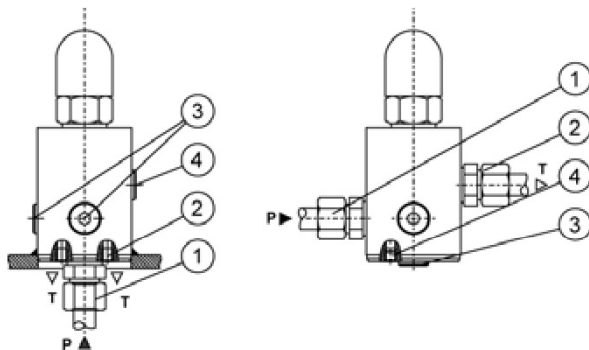
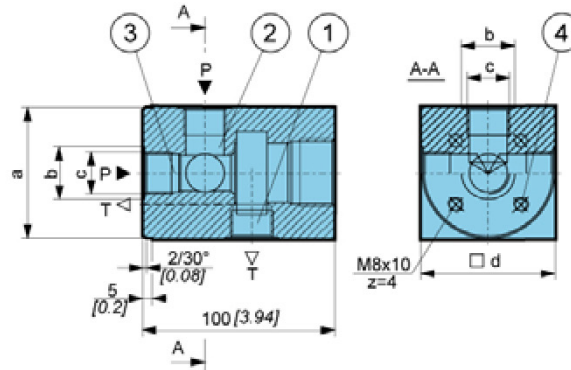

- 1. Port "P".
- 2. Return line "T".
- 3. Locking screws - P line.
- 4. Locking screws - T line.

**ΔP-Q Performance curves**

Measured at 50°C [122 °F] and viscosity of 32 mm<sup>2</sup>/s [148 SUS].

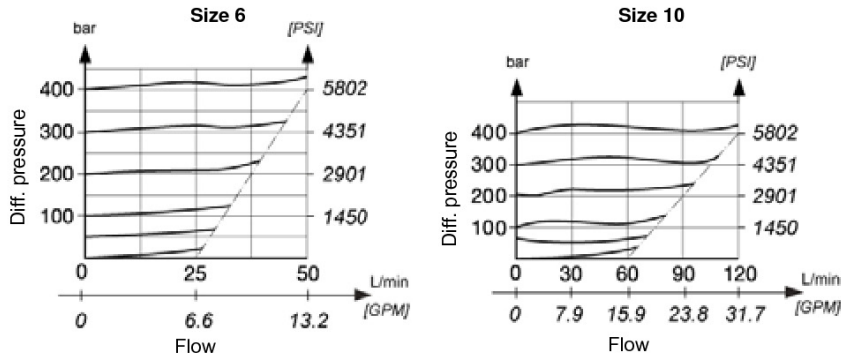

**Model code**

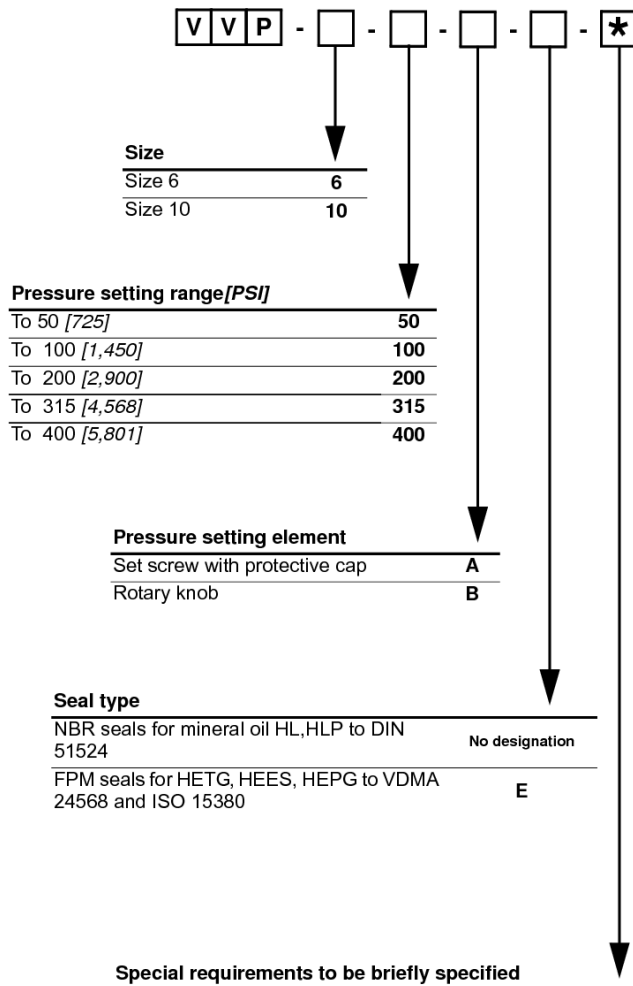

## PRESSURE RELIEF VALVE VVB2-10

- NG 6
- Up to 210 bar [3,045 PSI]
- Up to 60 L/min [15,8 GPM]
- Direct in-line mounting.
- Threaded connections to ISO 9974 (Metric), ISO 1179 (BSPP/Gas).
- Five different pressure setting elements.

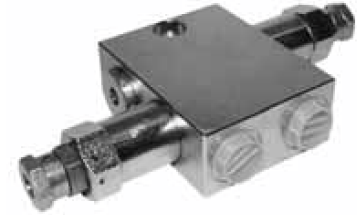

VVB2-10-...

### Features

Size	6	
Operating pressure	Bar [PSI]	210 [3 045]
Flow rate	L/min [GPM]	60 [15.8]
Pressure setting range	bar [PSI]	120 [1 740]; 160[2 320]; 200 [2 900]
Oil temperature range	°C [°F]	-10 to +70 [14 to + 158]
Viscosity range	mm <sup>2</sup> /s [SUS]	15 to 380 [69.5 to + 1,760]
Filtration	ISO 4406-1999	19/17/14
Mass	kg [lbs]	1.85 [4.08]
Seal type	NBR seals for mineral oil HL, HLP, to DIN 51524	

### Hydraulic symbol

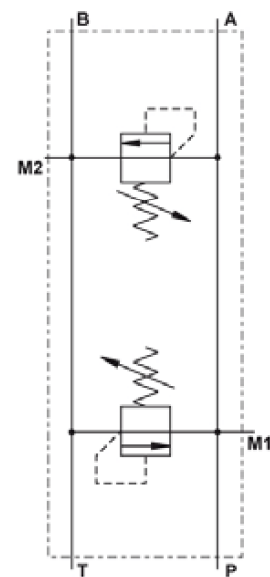

### ΔP-Q Performance curves

Measured at 50°C [122 °F] and viscosity of 32 mm<sup>2</sup>/s [148 SUS].

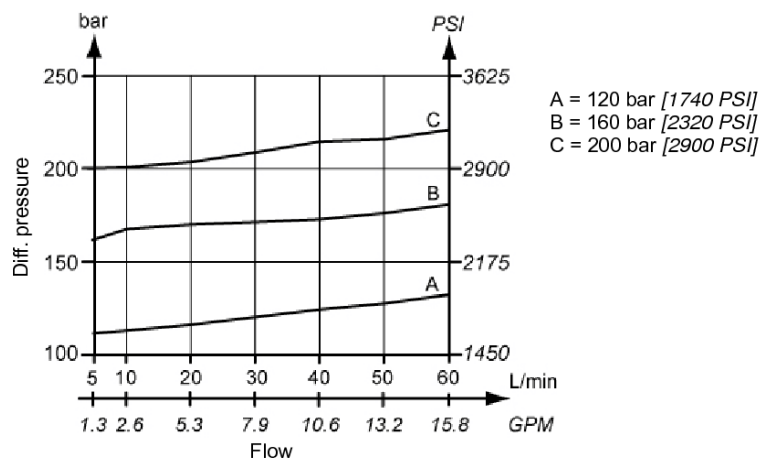

Dimensions

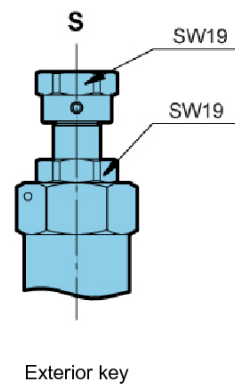
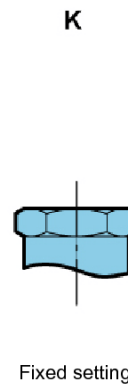
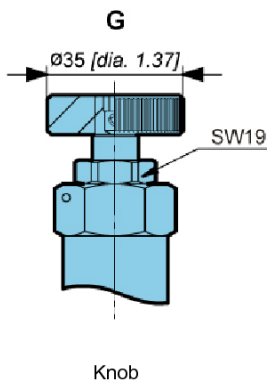
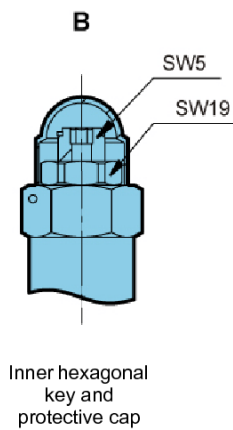
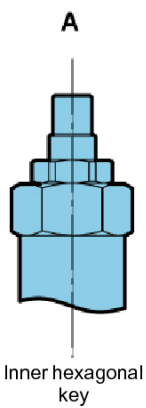
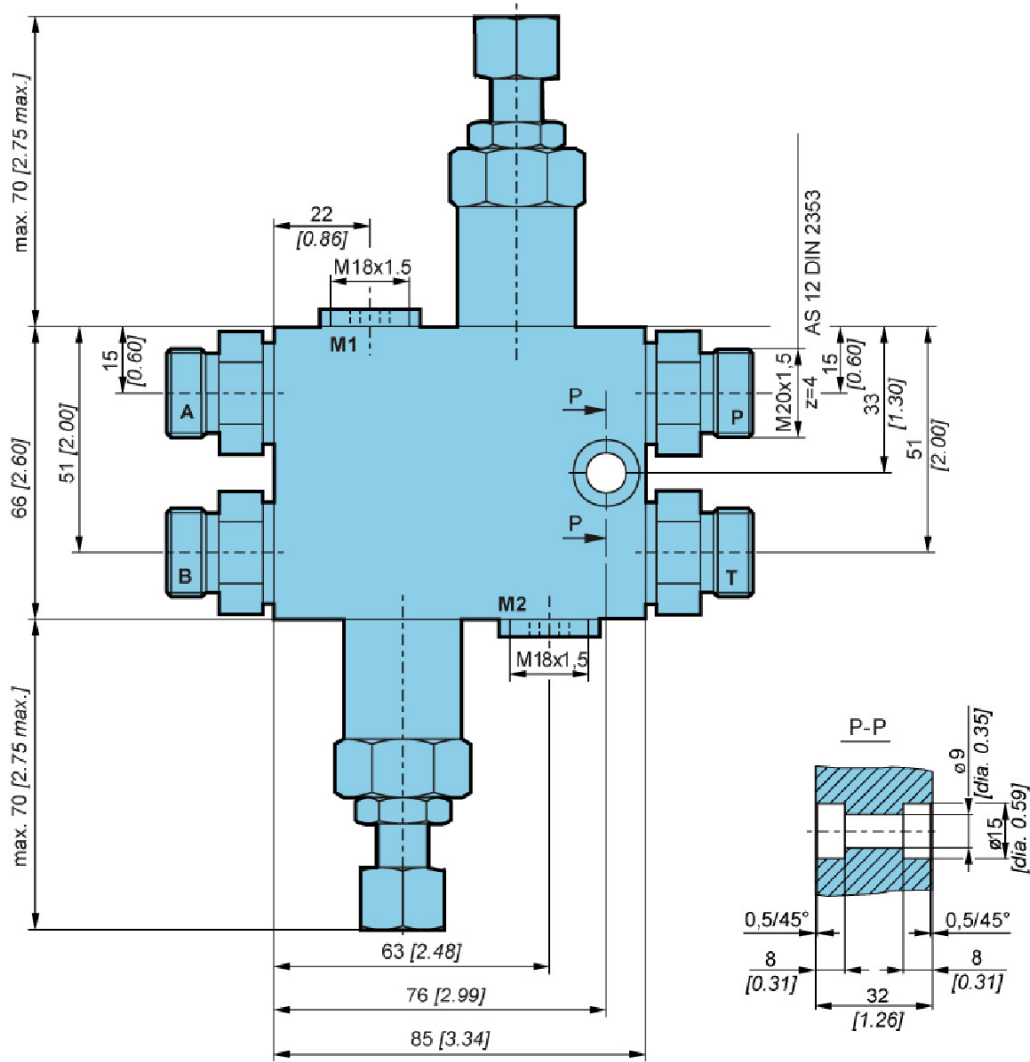

**Model code**

V V B 2 - 1 0 - □ - □ - □ - \*

**Pressure setting range [PSI]**

120 [1740]	120
160 [2 320]	160
200 Bar [2 900 PSI]	200

**Pressure setting element**

Inner hexagonal key	A
Inner hexagonal key and protective cap	B
Knob	G
Fixed setting	K
Exterior key	S

**Threaded connections**

M18 x 1,5	No designation
G 3/8	3/8

**Special requirements to be briefly specified**

# PRESSURE RELIEF VALVE RT

- NG 4, 6, 10
- Up to 350 bar [3,045 PSI]
- Up to 60 L/min [26.4 GPM]
- For independent fitting into a block.
- Two pressure setting ranges.



RT-4, RT-6, RT-10

## Operation

Pilot operated pressure relief valves type RT are used for maintaining and limiting the pressure in a hydraulic system. These valves consist of a housing of cartridge design (1), main spool insert (2) with a spring (3), pilot poppet (4), spring (5) and pressure setting element (6). The P-line of this pressure relief valve is connected with the hydraulic system. The hydraulic medium pressure acts on the front side of the main spool insert. The bores (7,8) permit the introduction of pilot oil into the pressure chamber (9) and the application of pressure to the opposite side of the main spool insert and the front side of the pilot poppet. The pressure balance in the system and pressure chamber holds this pressure relief valve in closed position till the pressure in system exceeds this value the pilot poppet moves off the valve seat, freeing the pilot oil discharge through the bore (10). A pressure drop in the pressure chamber rises the main spool insert, thus clearing the hydraulic medium flow way in the direction from P towards port T. Loosening of the pressure setting element (6) is prevented by a counternut (11).

## Hydraulic symbol

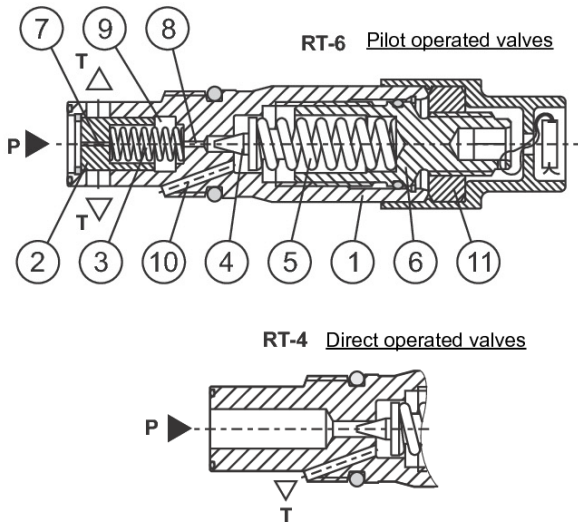
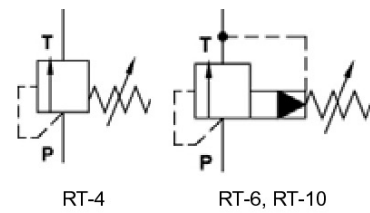

## Features

Size		4	6	10
Flow rate	L/min [GPM]	4 [1.1]	60 [15.8]	100 [26.4]
Pressure setting range	bar [PSI]	315 [4 568]		
Oil temperature range	°C [°F]	-20 to +70 [-4 to + 158]		
Viscosity range	mm <sup>2</sup> /s [SUS]	15 to 380 [69.5 to + 1,760]		
Filtration	NAS 1638	8		
Mass	kg [lbs]	0,15 [0.33]		0,18 [0.40]

**Dimensions**

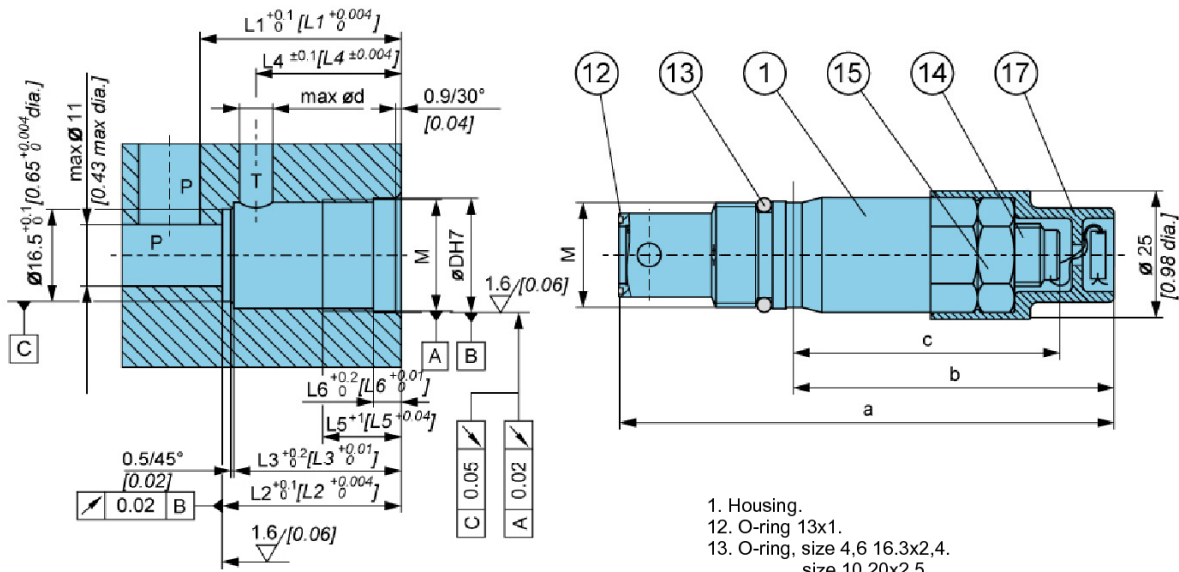

- 1. Housing.
- 12. O-ring 13x1.
- 13. O-ring, size 4,6 16.3x2,4, size 10 20x2,5.
- 14. Pressure setting element.
- 15. Counternut.
- 17. PE cover.

Tightening torque for fixing Md=30 Nm.

The value set on the pressure setting element is protected by means of a lead stamp Ø11 and a wire Ø1,1 mm.

Note: Ports P and T can be located optionally at any place on the circumference.

Size	a	b	c	d	D	L1	L2	L3	L4	L5	L6	M
4, 6	96 [3.78]	64 [2.52]	53 [2.09]	6 [0.24]	20,5 [0.81]	36 [1.42]	32 [1.26]	30 [1.18]	26 [1.02]	14 [0.55]	4,8 [0.19]	M20x1
10	97 [3.82]	61 [2.40]	50 [1.97]	10,5 [0.41]	24,5 [0.96]	40 [1.57]	36 [1.42]	34 [1.34]	29,7 [1.17]	15 [0.59]	5,2 [0.20]	M24x1

**ΔP-Q Performance curves**

Measured at 50°C [122 °F] and viscosity of 32 mm<sup>2</sup>/s [148 SUS].

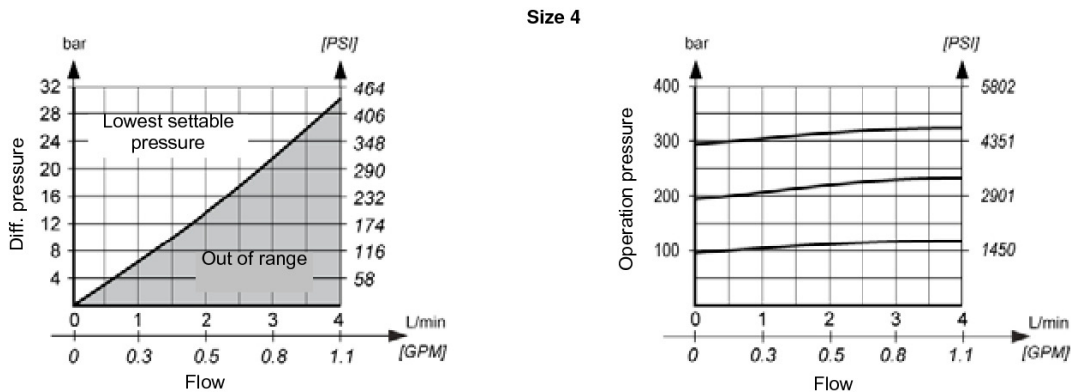

**ΔP-Q Performance curves**

Measured at 50°C [122°F] and viscosity of 32 mm<sup>2</sup>/s [148 SUS].

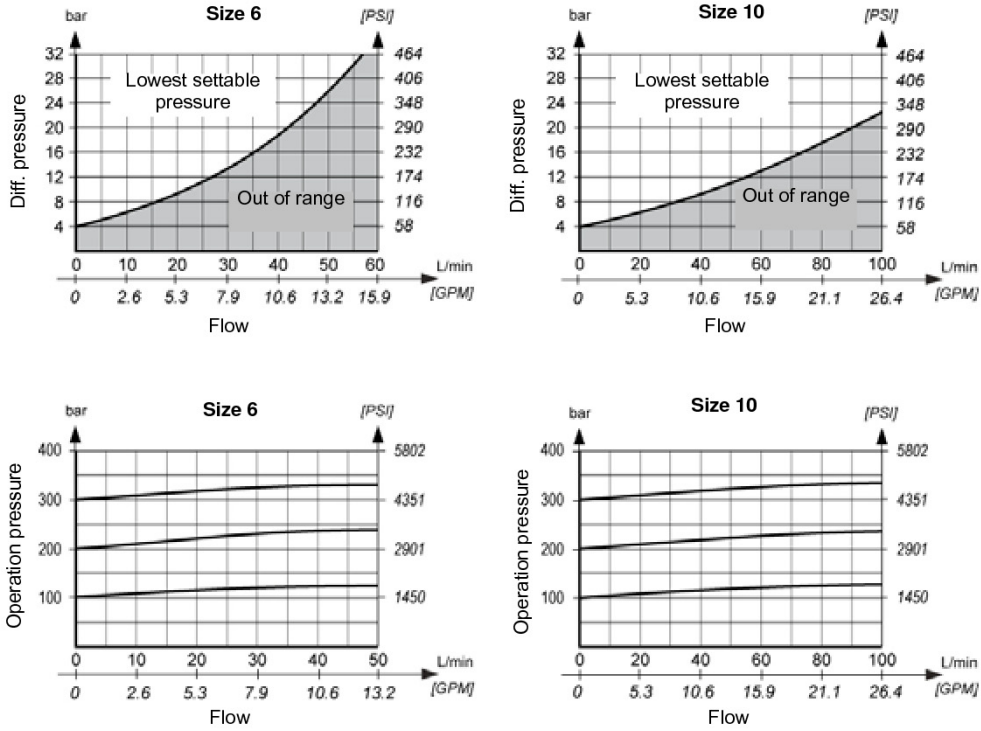

**Model code**

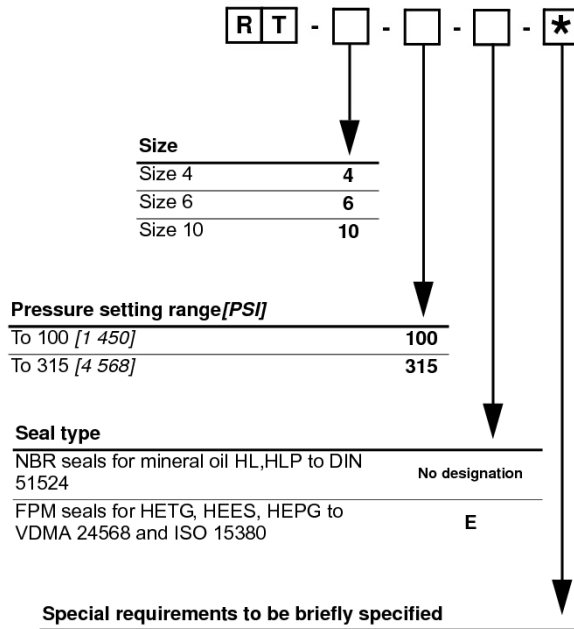

# PRESSURE RELIEF VALVE VP-RT

- NG 6, 10
- Up to 350 Bar [3,045 PSI]
- Up to 100 l/min [26.4 GPM]
- Connecting dimensions to ISO 4401.
- For vertical stacking - sandwich plate design.
- Two pressure setting ranges.



VP-RT-10, VP-RT-6

## Operation

These valves consist of a stack plate (1), pressure relief valve housing (2), main spool insert (3) with a spring (4), pilot poppet (5), spring (6) and pressure setting element (7). The P-line of this pressure relief valve is connected with the hydraulic system. The hydraulic medium pressure acts on the front side of the main spool insert (3). The bores (8,9) permit the introduction of pilot oil into the pressure chamber (10) and the application of pressure to the opposite side of the main spool insert. This pressure relief valve remains in closed position till the system pressure exceeds the valve set at the spring (6). A pressure rise in the system above the value set by the pressure setting element (7), provokes the movement of the pilot poppet (5) of the seat, freeing the pilot oil discharge through the bores (9) and (11). A pressure drop in the pressure chamber (10) rises the main spool insert (3), thus clearing the hydraulic medium flow in the direction from port P towards port T.

Loosening of the pressure setting element is prevented by a counter nut (12).

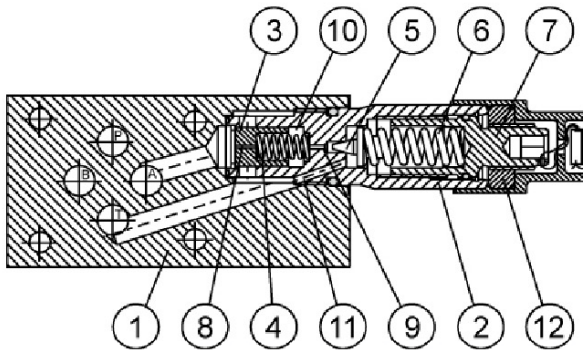

Pilot operated pressure relief valves type VP-RT of sandwich plate design, for vertical stacking, are used for maintaining and limiting the maximum pressure in a hydraulic system.

## Hydraulic symbol

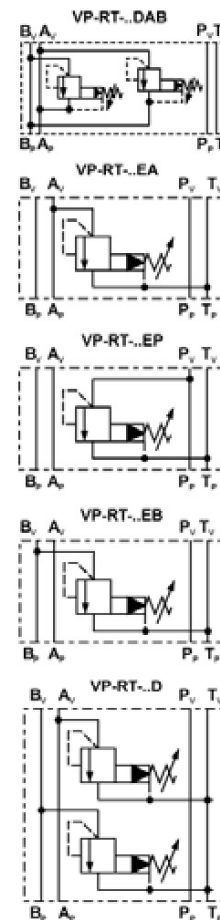

## Features

Size		6	10
Flow rate	l/min [GPM]	50 [13.2]	100 [26.4]
Pressure setting range	Bar [PSI]	315 [4 568]	
Oil temperature range	°C [°F]	-20 to +70 [-4 to +158]	
Viscosity range	mm <sup>2</sup> /s [SUS]	15 to 380 [69.5 to + 1,760]	
Filtration	NAS 1638	8	
Mass	kg [lbs]	1,2 [2,64] - 1,7 [3,75] (D)	2,6 [5.73]

## Dimensions

### VP-RT-6

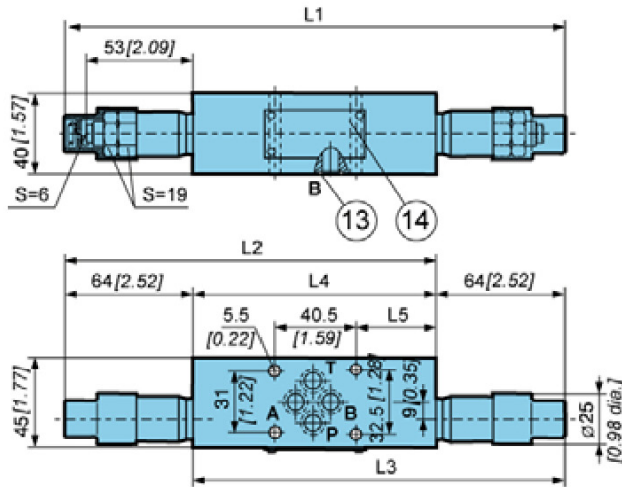

13. O-ring, Size 6: 9,25x1,78  
Size 10: 12x2.

14. Nameplate

The value set on the pressure setting element is protected by means of a lead stamp  $\varnothing 11$  [0.43 dia.] and a wire  $\varnothing 1,1$  [0.04 dia.].

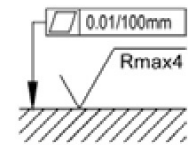

Required quality of the mating surface

### VP-RT-10

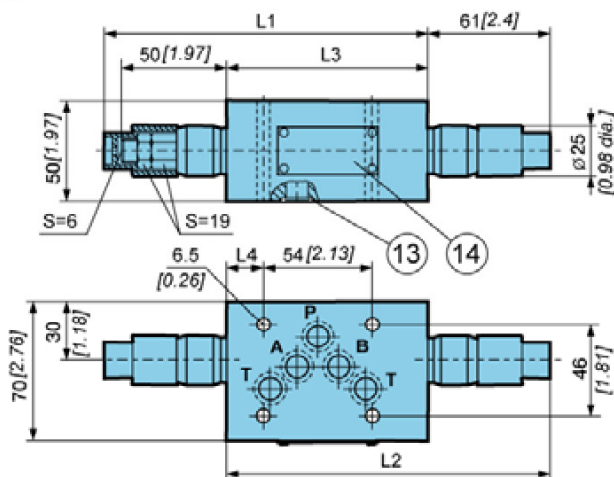

Size	L1	L2	L3	L4	L5
VP-RT-6-EA	-	154 [6.06]	-	-	9 [0.35]
VP-RT-6-EB	-	-	-	90 [3.54]	40,5 [1.59]
VP-RT-6-EP	-	-	154 [6.06]	-	-
VP-RT-6-D	249 [9.80]	-	-	121 [4.76]	40 [1.57]
VP-RT-6-DAB	245 [9.64]	-	-	116,5 [4.59]	38 [1.50]
VP-RT-10-EP	156 [6.14]	-	95,5 [3.76]	-	-
VP-RT-10-EA	161 [6.34]	-	-	28,5 [1.12]	-
VP-RT-10-EB	-	161 [6.34]	100,5 [3.96]	18 [0.71]	-

**ΔP-Q Performance curves**

Measured at 50°C [122 °F] and viscosity of 32 mm<sup>2</sup>/s [148 SUS].

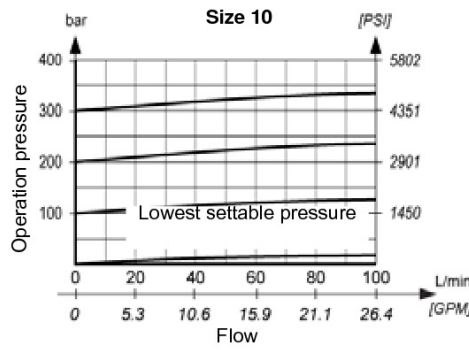
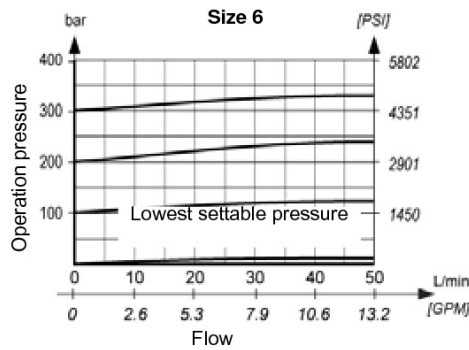
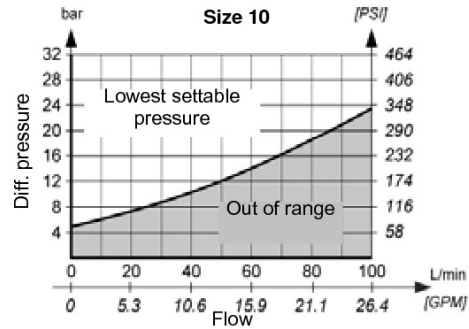
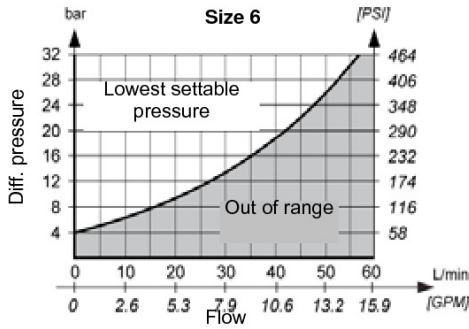

**Model code**

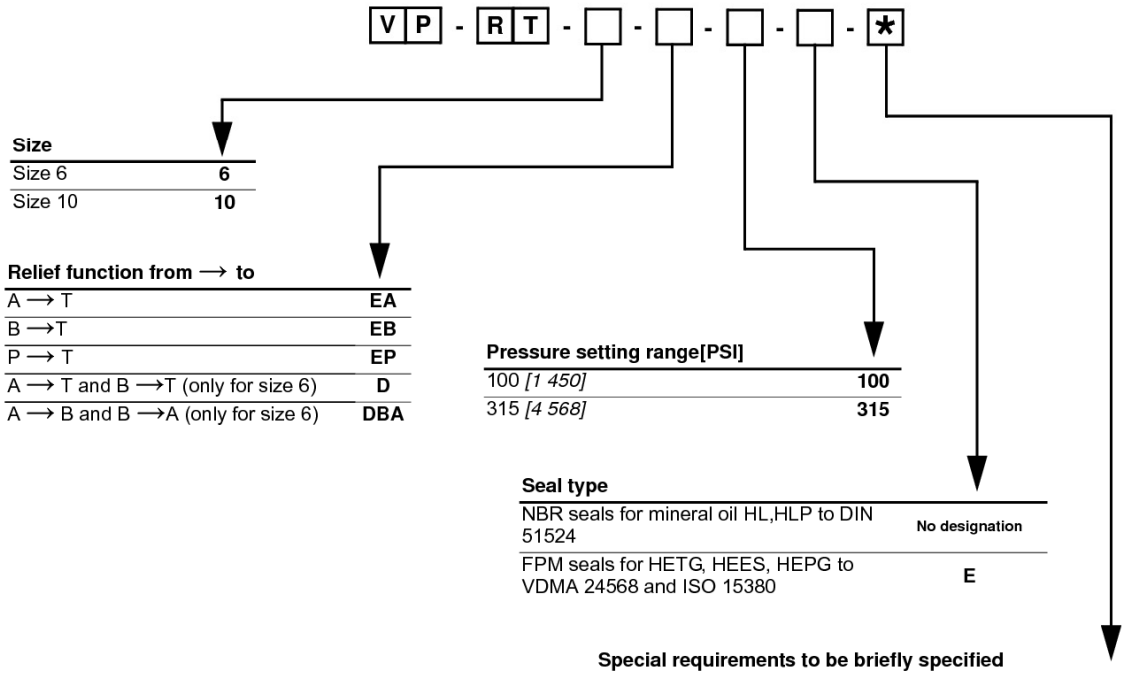

## CHARACTERISTICS

