



FLOW CONTROL VALVES



TVD-6. VALVES.

FLOW CONTROL VALVES



THROTTLE WITH CHECK VALVES

Throttle with check valve VP-NDV (NG 6, 10)

5

5

Throttle with Check valves

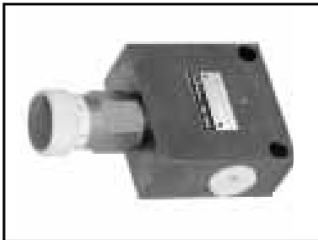

FLOW CONTROL VALVES PRESSURE COMPENSATED

- Flow control valve TVD (NG 6)
- Flow control valve TVTC (NG 6)
- Flow control valve TVTP-...-B-... (NG 6, 10)
- Flow control valve TVTP-...-P-... (NG 6, 10)

9

9

13

17

21

Flow control valves pressure compensated



FLOW DIVIDERS

Flow divider DTP (NG 6, 10)

25

25

Flow dividers

THROTTLE WITH CHECK VALVE VP-NDV

- NG 6, 10
- Up to 350 Bar [5,076 PSI]
- Up to 100 l/min [26,4 GPM]
- Connecting dimensions to ISO 4401.
- For flow control in both service lines.
- For throttling in supply - and return lines.
- For vertical stacking - sandwich plate design.
- Height and width of the valves to ISO 7790 norms.



VP-NDV-10-..., VP-NDV-6-..

Operation

Throttle with check valves type VP-NDV are used for throttling the pilot and main flow of the hydraulic fluid in the line A and B.

These valves consist of two throttling spools with setting screws and two check valves which are built in a housing.

In direction V to P (see the hydraulic symbol) flows the hydraulic fluid with low pressure loss through the check valve.

In direction P to V is the hydraulic fluid flow throttled depending on adjustment of the throttling spool.

Hydraulic symbol

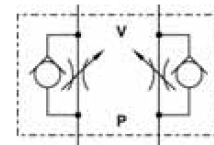

Mounting example

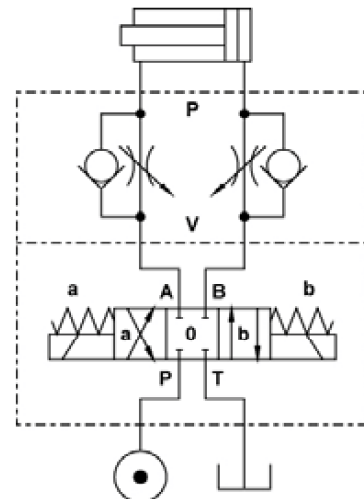

Features

Size		6	10
Flow rate	l/min [GPM]	60 [15,8]	100 [26,4]
Operating pressure	Bar [PSI]	350 [5 076]	
Cracking pressure	Bar [PSI]	0,4 [5,8]	
Oil temperature range	°C [°F]	-20 to +70 [-4 to +158]	
Viscosity range	mm ² /s [SUS]	15 to 380 [69,5 to 1760]	
Filtration	NAS 1638	8	
Mass	kg [lbs]	1,45 [3,20]	3,3 [7,28]

Dimensions

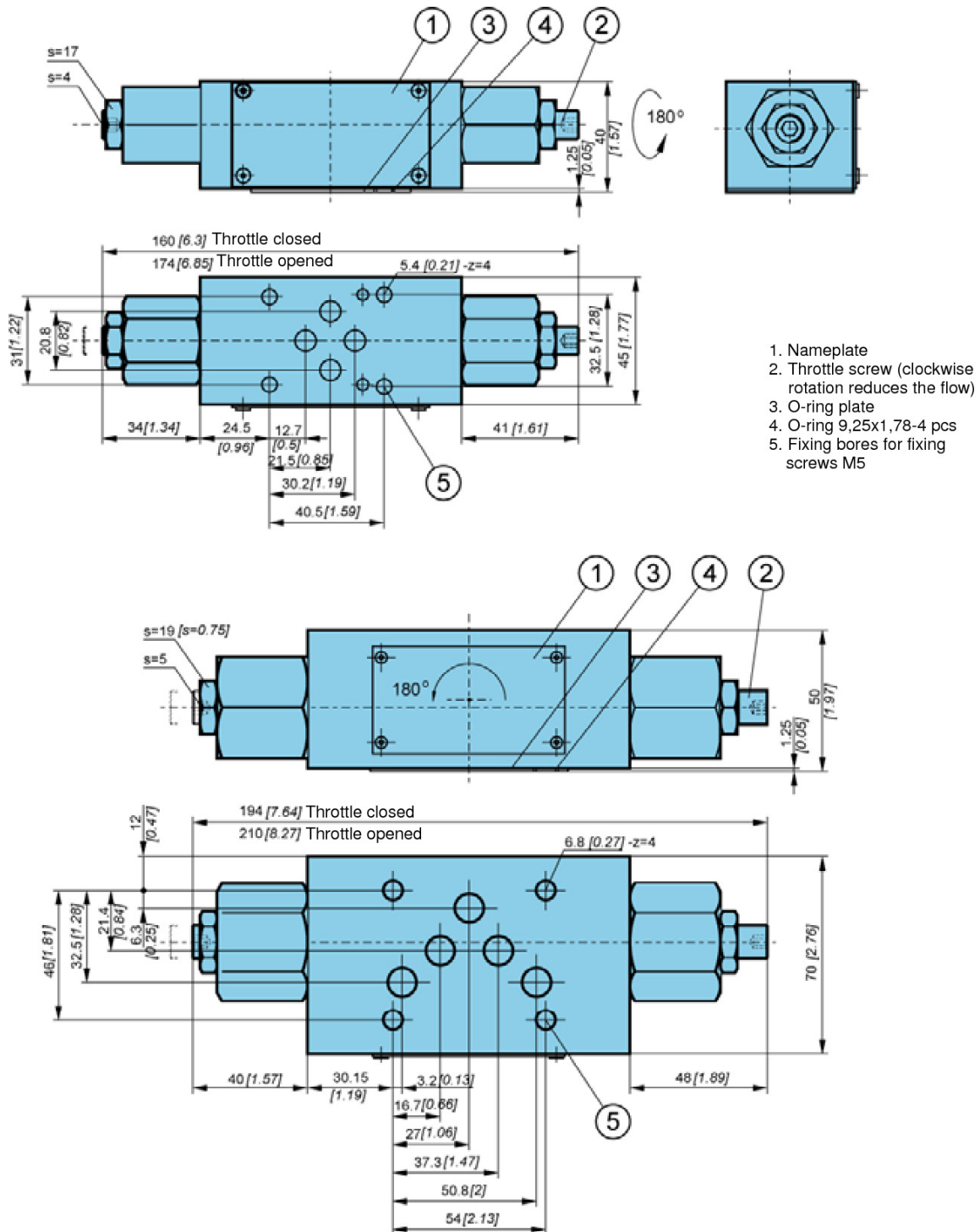

Assembly instructions

Throttle/check valves type VP-NDV are designed for vertical stacking. With these valves there can be throttling of the hydraulic fluid flow in return line or supply line achieved. Direction of throttling can be selected by turning the installation position of the valve i.e. valves size 6 turning 180° around the longitudinal axis; valves size 10 turning 180° around the lateral axis (see drawing above). The O-ring plate is always mounted on the subplate side.

ΔP-Q Performance curves

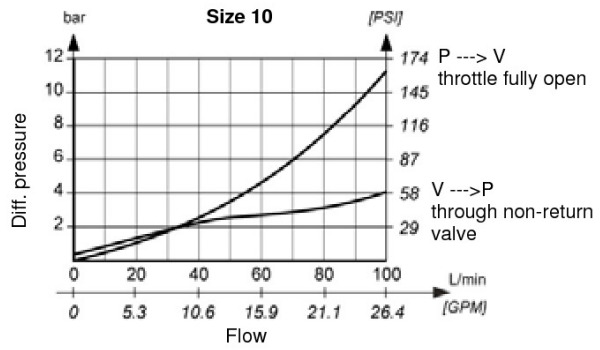
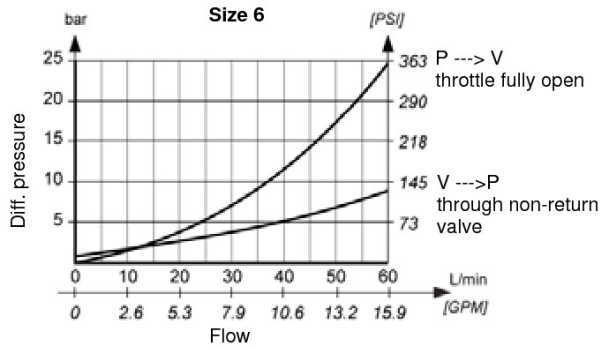

Model code

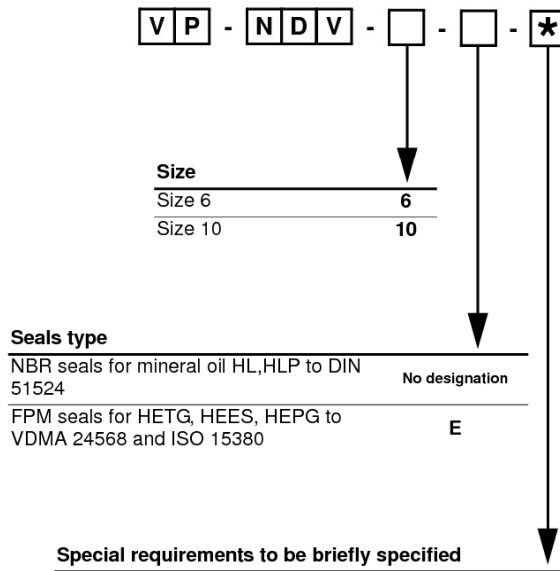

FLOW CONTROL VALVE TVD

- NG 6
- Up to 350 Bar [5076 PSI]
- Up to 16 l/min [4,23 GPM]
- Two - way pressure compensated.
- Connecting dimensions to ISO 6264.
- Operating elements: rotary knob / roller.
- With built - in non-return valve.
- Without built - in non-return valve.



TVD-6

Operation

Flow control valves type TVD are used to set the flow of the hydraulic fluid. The flow depends neither on inlet nor on outlet pressures, which means that the flow setpoint valve remains constant also with a change of the pressure drop.

These valves consist of a housing (1), a pressure compensator (2), an orifice (3), a setting element (4), and a non-return valve (5).

The hydraulic fluid flow is adjusted by a setting element (4) which moves the orifice (3) to the corresponding open position. The flow of the fluid is throttled in the direction from A to B. Maintaining of the constant flow towards the user is provided by the pressure compensator (2). The fluid flows through the bore (6) under the pressure compensator, acting on it by the pressure of the line B. From the opposite side, the pressure compensator is acted upon by the pressure which is before the orifice (3). The pressure compensator shifts the working position. A pressure built - up in the line B provokes the movement of the pressure compensator to the increased open position. This enlarges the gap between the bores (7), the orifice (3) and the user. On the contrary, the pressure compensator shifts to the closed position if there is a pressure rise in the line A. The hydraulic fluid flow is constant, and does not depend on the loads on the user.

The non-return valve (5) provides a free flow of the hydraulic fluid in the direction from B to A.

The flow control valve without the non-return valve (5) provides operation of the valve only in the direction of the flow from A to B.

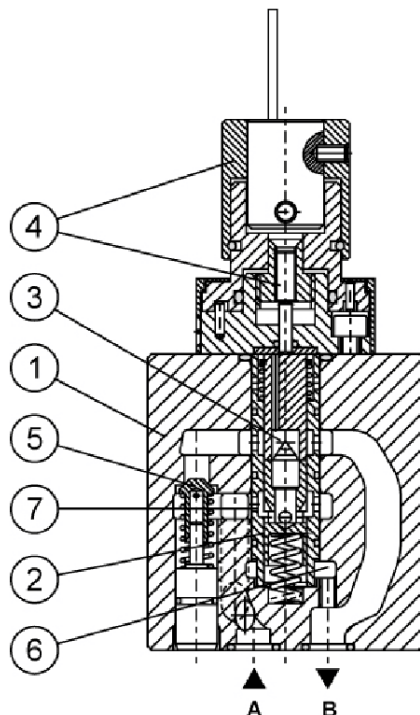

Hydraulic symbol

TVD-6

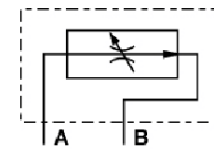

TVD-6-NV

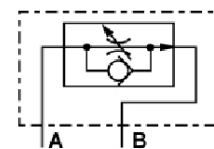

Detailed

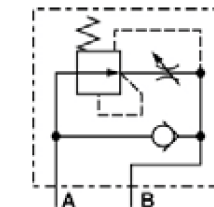

Features

Type		TVD-6-0,9	TVD-6-2	TVD-6-4	TVD-6-8	TVD-6-16
Flow rate	l/min [GPM]	0,9 [0,23]	2 [0,53]	4 [1,06]	8 [2,11]	16 [4,23]
Operating pressure	Bar [PSI]	100 [1450,38]			350 [5076,32]	
Min. pressure drop	Bar [PSI]	4 [58,01]		10-12 [145-174]	10-14 [145-203]	10-16 [145-232]
Oil temperature range	°C [°F]	-20 to +70 [-4 to +158]				
Viscosity range	mm ² /s [SUS]	15 to 380 [69,5 to 1760]				
Filtration	NAS 1638	8				
Mass	kg [lbs]	1,6 [3,53]				

Dimensions

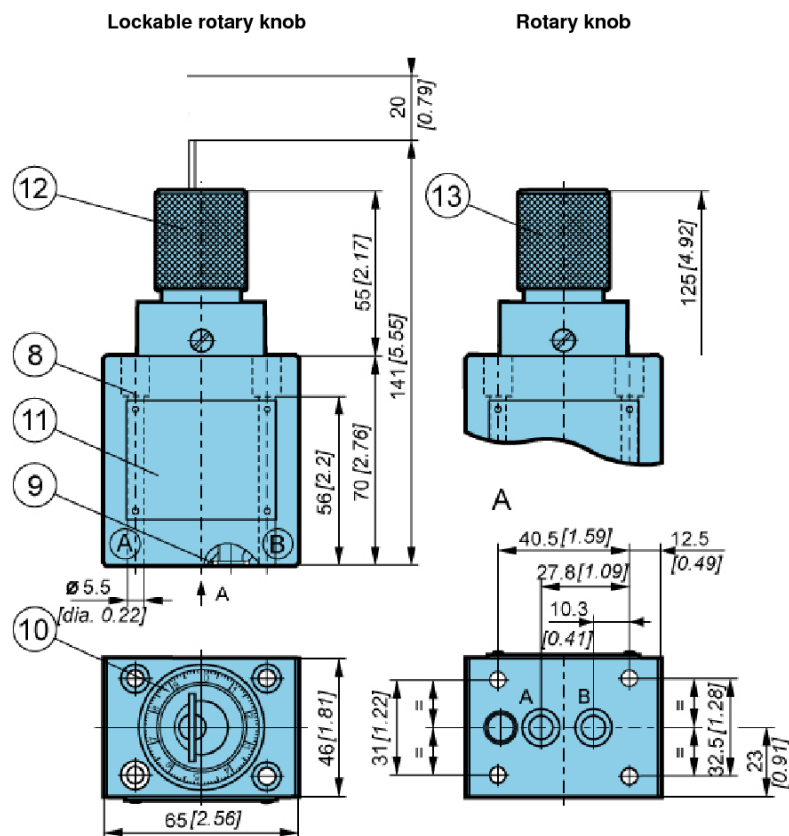

- 8. 4 pcs fixing screws M5 x 65 to ISO 4762-10.9
tightening torque Md=9 Nm
- 9. O-ring 9,25 x 1,78
- 10. Scale for setting
read - out
- 11. Nameplate
- 12. Lockable rotary knob
- 13. Rotary knob

Required quality of the mating surface

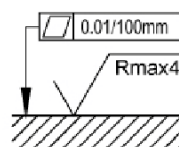

ΔP-Q Performance curves

Measured at 50°C [122°F] and viscosity of 32 mm²/s [148 SUS].

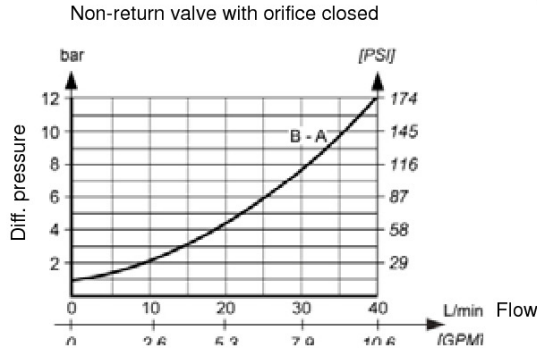
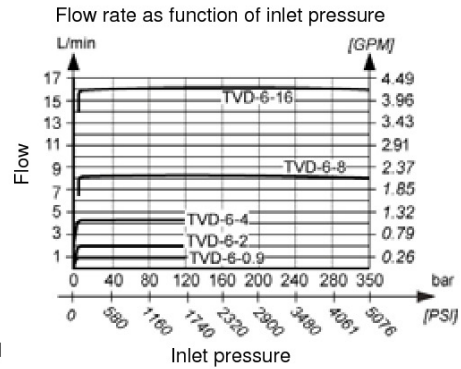
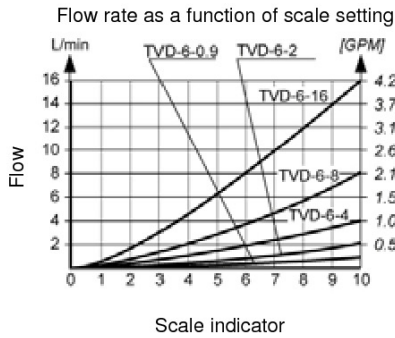

Model code

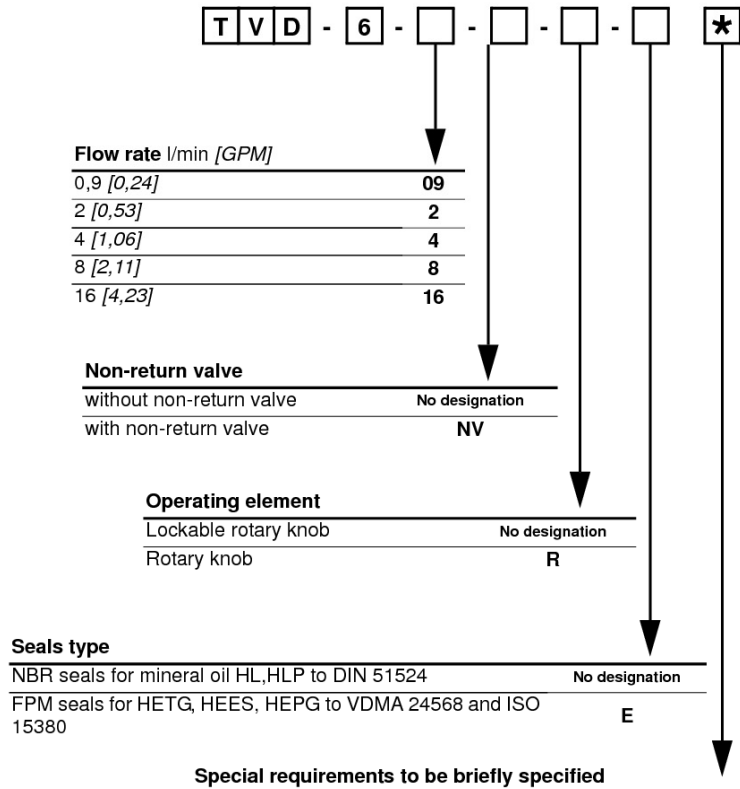

FLOW CONTROL VALVE TVTC

- NG 6
- Up to 350 Bar [5076 PSI]
- Up to 50 l/min [13,21 GPM]
- Three-way pressure compensator.
- Operating element: rotary knob.
- Without built - in relief valve and non return valve.
- With built - in relief valve.
- With built-in non return valve.
- Threaded connections to ISO 1179 (BSPP/Gas), ISO 11926 (UNF).



TVTC-..

Operation

3-way compensated flow control valve enables setting of constant fluid flow on port A irrespective of the pressure variations. The excessive flow rate is discharged to port B and can be used as a secondary working port or return port to a tank.

When the port B is used as a secondary working port the pressure must not exceed the pressure on port A.

A pressure relief valve in valve type TVTC-..-VV limits the pressure in port A on the set valve. The excessive flow rate is discharged over port R to a tank.

The non return valve in valve type TVTC -..-NV provides a free flow of the hydraulic fluid in the direction from A to P.

Hydraulic symbol

TVTC-..

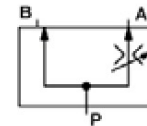

TVTC-..-VV

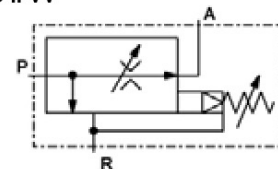

TVTC-..-NV

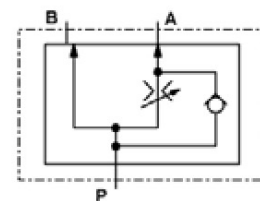

Features

Type		TVTC-12-...	TVTC-25-...	TVTC-50-...
Flow rate A	l/min [GPM]	1 to 12 [0,26 to 13,17]	1 to 25 [0,26 to 6,60]	1 to 50 [0,26 to 13,21]
Max. flow rate A	l/min [GPM]	32 [8,45]	65 [17,17]	
Operating pressure	Bar [PSI]	5 to 350 [72,52 to 5076,32]		
Differential pressure	Bar [PSI]	5,5		
Cracking pressure for non return valve	Bar [PSI]	0,5		
Flow stability (5 to 350 Bar)	%	±5 (Q)		
Oil temperature range	°C [°F]	-20 to +70 [-4 to +158]		
Viscosity range	mm ² /s [SUS]	15 to 380 [69,5 to 1760]		
Filtration	NAS 1638	8		
Mass	kg [lbs]	TVTC		
		TVTC-..-NV	2 [4,41]	
		TVTC-..-VV	3 [6,61]	

ΔP-Q Performance curves

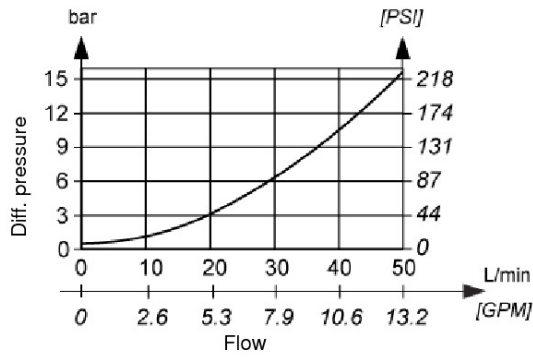

Flow rate as a function of scale indication

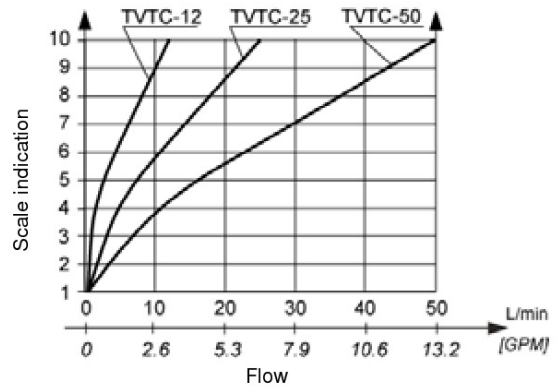

Model code

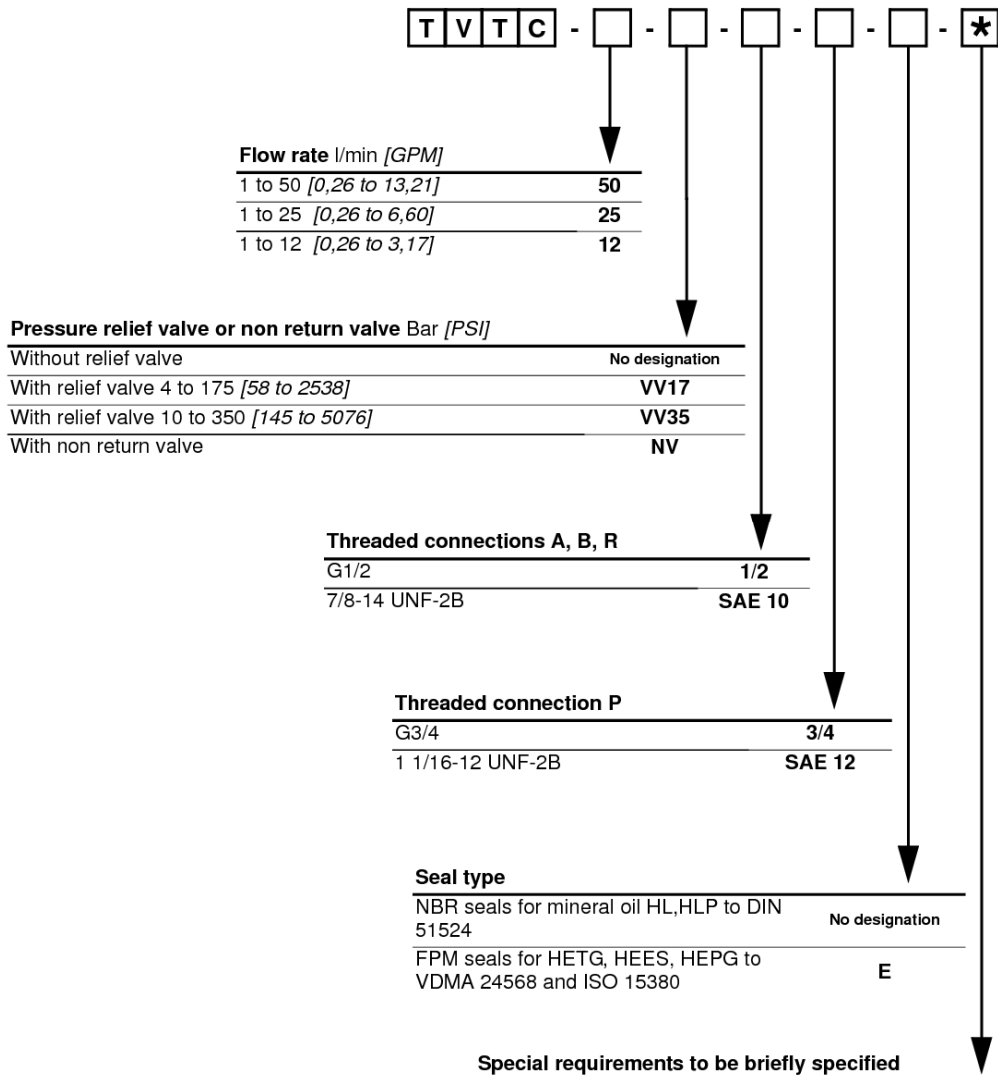

FLOW CONTROL VALVE TVTP-...-B-...

- NG 6, 10
- Up to 350 Bar [5076 PSI]
- Up to 90 l/min [23,78 GPM]
- Three-way pressure compensated.
- Operating element: rotary knob.
- For independent fitting into a block.



TVTP-...-B-...

Operation

TVTP three-way flow regulators are used to regulate the priority flow in outlet 3 to a maximum adjustable level largely independent of the load and pressure conditions. The surplus flow is diverted to the bypass port 2. The bypass flow may be used for a secondary circuit. Whether the pressure in secondary circuit is higher than the regulated pressure the valve works as two-way regulator.

Hydraulic symbol

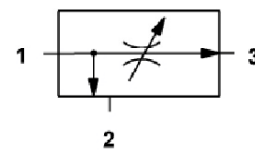

Features

Type		TVTP-25-B	TVTP-60-B	TVTP-90-B
Rated flow 3	l/min [GPM]	25 [6,60]	60 [15,85]	90 [23,78]
Flow rate 1 max.	l/min [GPM]	60 [15,85]	90 [23,78]	150 [39,63]
Operating pressure max.	Bar [PSI]	350 [5076]		
Oil temperature range	°C [°F]	-20 to +70 [-4 to +158]		
Viscosity range	mm ² /s [SUS]	15 bis to 380 [69,5 to 1760]		
Filtration	NAS 1638	8		
Mass	kg [lbs]	0,6 [1,32]		1 [2,20]

Flow rate as a function of scale indication

Measured at 50 °C [122 °F] and viscosity of 32 mm²/s [148 SUS].

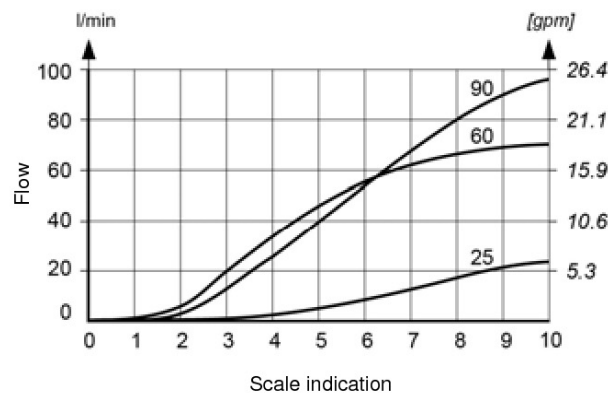

Dimensions

TVTP-...-B-...

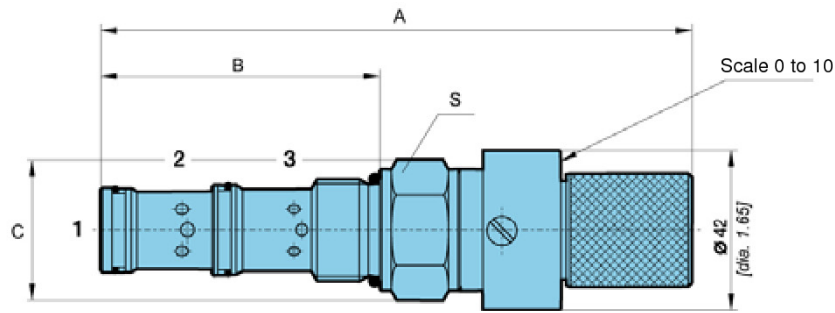

Typ	A mm [Zoll]	B mm [Zoll]	C mm [Zoll]	S	Torque into Cavity Nm [in.lbf]
TVTP-25-B	155 [6,10]	73,5 [2,83]	37 [1,46]	S32	60 - 65 [531 - 575]
TVTP-60-B	176 [6,93]	75 [2,95]	46 [1,81]	S41	70 - 75 [619 - 664]

Dimensions of cavity

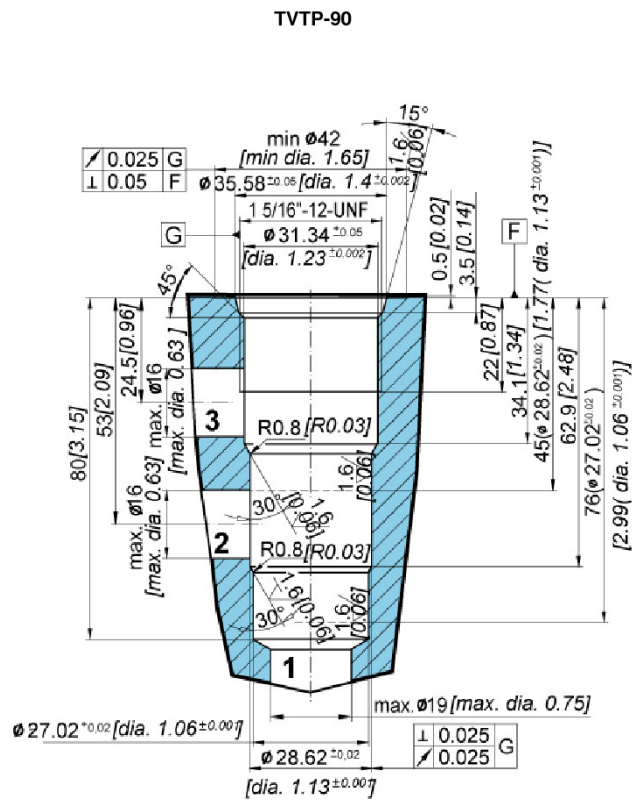
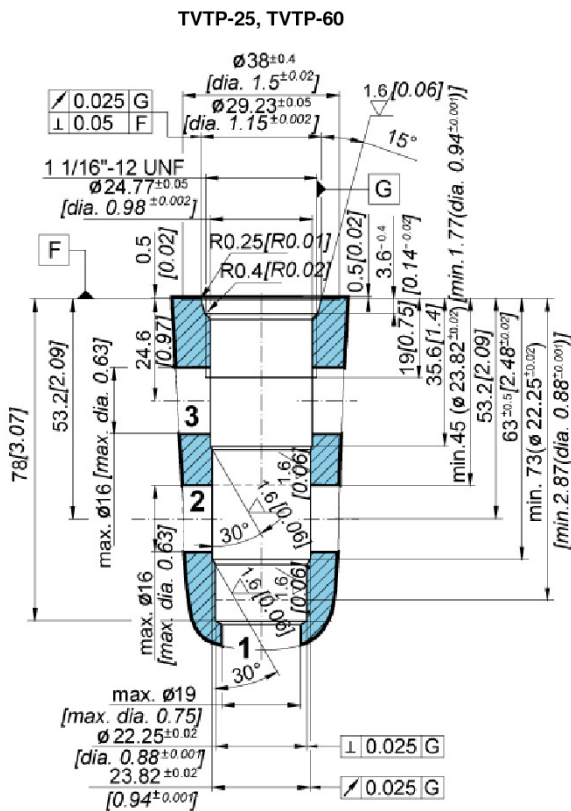

Standard ported body - steel

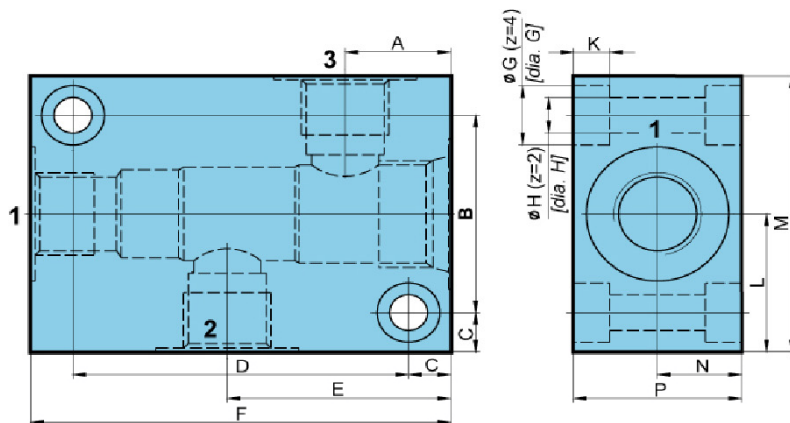

	P-TVTP-50 mm [Zoll]	P-TVTP-90 mm [Zoll]
A	25,1 [0,99]	25 [0,98]
B	50 [1,97]	65 [2,56]
C	10 [0,40]	15 [0,59]
D	80 [3,15]	80 [3,15]
E	53,2 [2,10]	53,5 [2,11]
F	100 [3,94]	110 [4,33]
G	15 [0,59]	17 [0,67]
H	9 [0,35]	11 [0,43]
K	8,6 [0,34]	10,6 [0,42]
L	35 [1,37]	47,5 [1,87]
M	70 [2,75]	95 [3,74]
N	20 [0,78]	26 [1,02]
P	40 [1,57]	52 [2,05]
U	G 1/2	G 1

Threaded connections to ISO 1179-1.

Model code

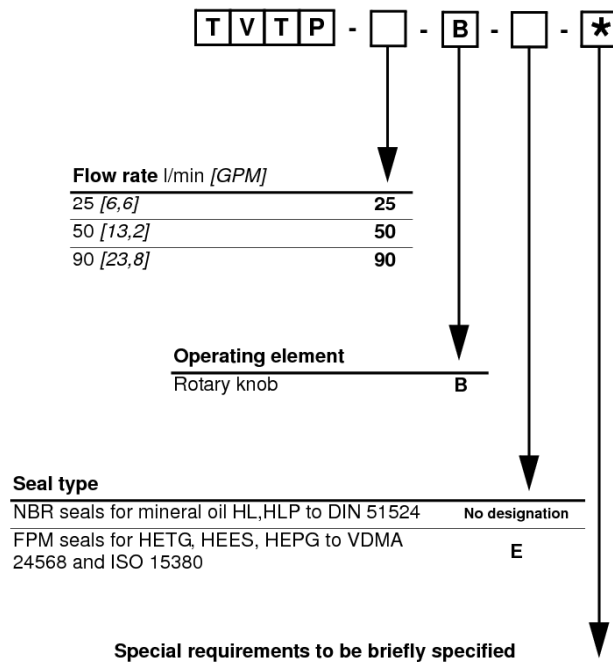

FLOW CONTROL VALVE TVTP-...-P-...

- NG 6, 10
- Up to 210 Bar [3046 PSI]
- Up to 90 l/min [23,8 GPM]
- Three-way pressure compensated.
- Operating element: proportional solenoid.
- Control electronics: Amplifier P/N: 1659574.
- For independent fitting into a block.
- Plug-in connector for solenoids to ISO 4400.
- Protection of solenoid IP 54 to EN 60529 / IEC 60529 (IP 65 on request).



TVTP-...-P-...

Operation

TVTP three-way flow regulators are used to regulate the priority flow in outlet 3 to a maximum adjustable level largely independent of the load and pressure conditions. The surplus flow is diverted to the bypass port 2. The bypass flow may be used for a secondary circuit.

Whether the pressure in secondary circuit is higher than the regulated pressure the valve works as two-way regulator.

Hydraulic symbol

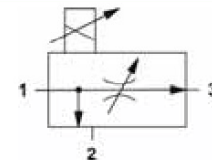

Features

Type		TVTP-25	TVTP-50	TVTP-90
Rated flow 3	l/min [GPM]	25 [6,6]	50 [13,2]	90 [23,8]
Flow rate 1 max.	l/min [GPM]	60 [15,9]	90 [23,8]	150 [39,6]
Operating pressure max.	Bar [PSI]		210 [3045,8]	
Hysteresis	%		<5	
Flow constant according to load pressure	%		<±2	
Oil temperature range	°C [°F]		-20 to +70 [-4 to +158]	
Viscosity range	mm ² /s [SUS]		15 to 380 [69,5 to 1761]	
Filtration	NAS 1638		7	
Mass	kg [lbs]	1 [2,2] (TVTP-..)		1,6 [3,5] (TVTP-..)
		1,2 [2,6] (TVTP-..G)		2 [4,4] (TVTP-..G)
Power	W		17,4	20,8
Voltage	V		12 and 24 DC	
Rated current at 12 V	A		1,25	1,79
Rated current at 24 V	A		0,68	0,81
Coil resistance at 12 V; 20 °C [68 °F]	Ohm		7,2	4,3
Coil resistance at 24 V; 20 °C [68 °F]	Ohm		24,6	21
Rating ED	%		100	

Solenoid current / flow curves

Measured at 50°C [122°F] and viscosity of 32 mm²/s [148 SUS].

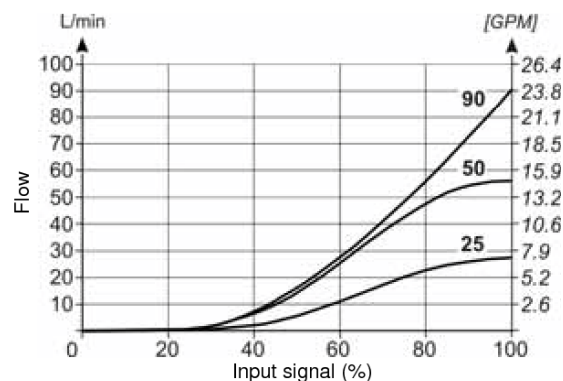

Standard ported body - steel

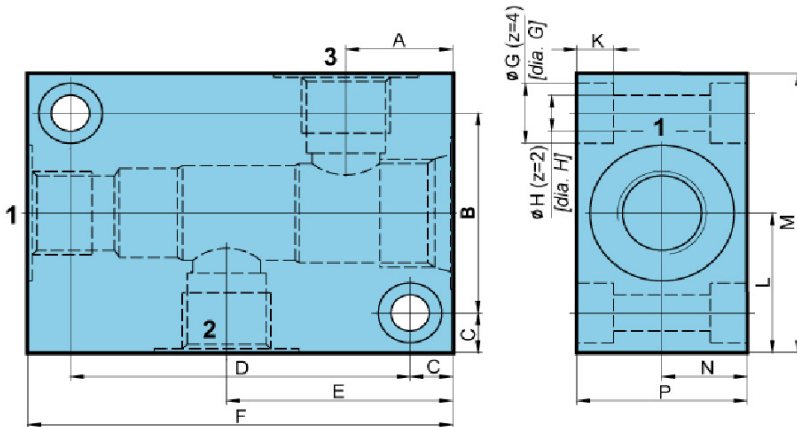

	P-TVTP-50 mm [Zoll]	P-TVTP-90 mm [Zoll]
A	25,1 [0,99]	25 [0,98]
B	50 [1,97]	65 [2,56]
C	10 [0,40]	15 [0,59]
D	80 [3,15]	80 [3,15]
E	53,2 [2,10]	53,5 [2,11]
F	100 [3,94]	110 [4,33]
G	15 [0,59]	17 [0,67]
H	9 [0,35]	11 [0,43]
K	8,6 [0,34]	10,6 [0,42]
L	35 [1,37]	47,5 [1,87]
M	70 [2,75]	95 [3,74]
N	20 [0,78]	26 [1,02]
P	40 [1,57]	52 [2,05]
U	G 1/2	G 1

Threaded connections to ISO 1179-1.

Model code

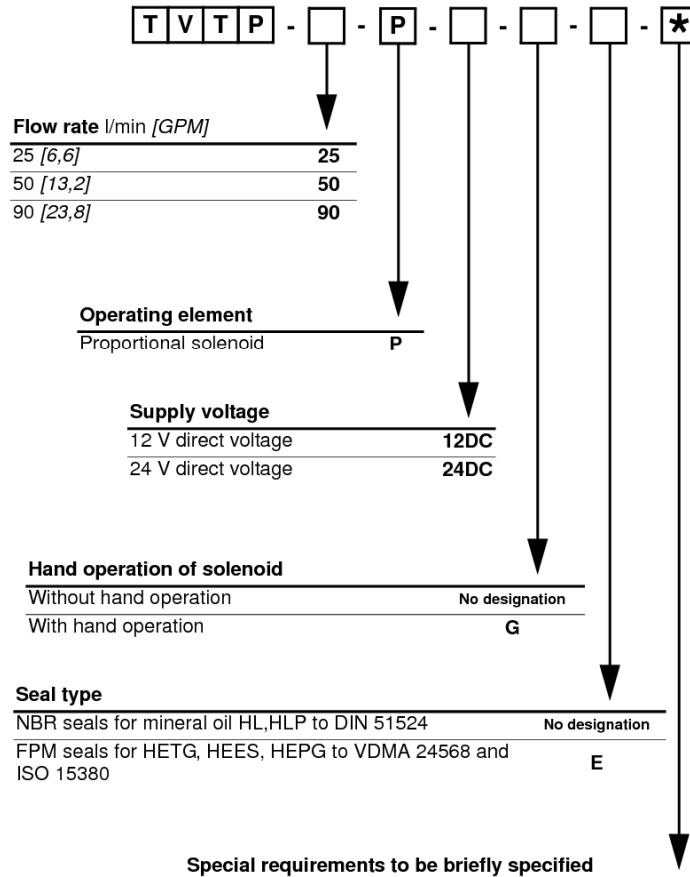

Standard ported body - steel

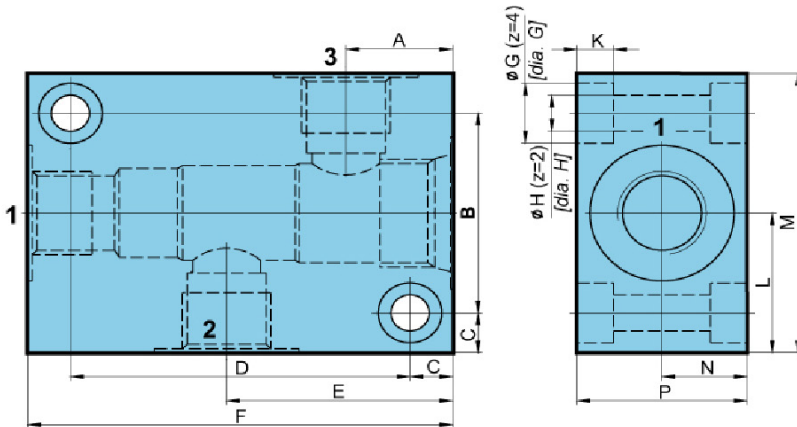

	P-TVTP-50 mm [Zoll]	P-TVTP-90 mm [Zoll]
A	25,1 [0,99]	25 [0,98]
B	50 [1,97]	65 [2,56]
C	10 [0,40]	15 [0,59]
D	80 [3,15]	80 [3,15]
E	53,2 [2,10]	53,5 [2,11]
F	100 [3,94]	110 [4,33]
G	15 [0,59]	17 [0,67]
H	9 [0,35]	11 [0,43]
K	8,6 [0,34]	10,6 [0,42]
L	35 [1,37]	47,5 [1,87]
M	70 [2,75]	95 [3,74]
N	20 [0,78]	26 [1,02]
P	40 [1,57]	52 [2,05]
U	G 1/2	G 1

Threaded connections to ISO 1179-1.

Model code

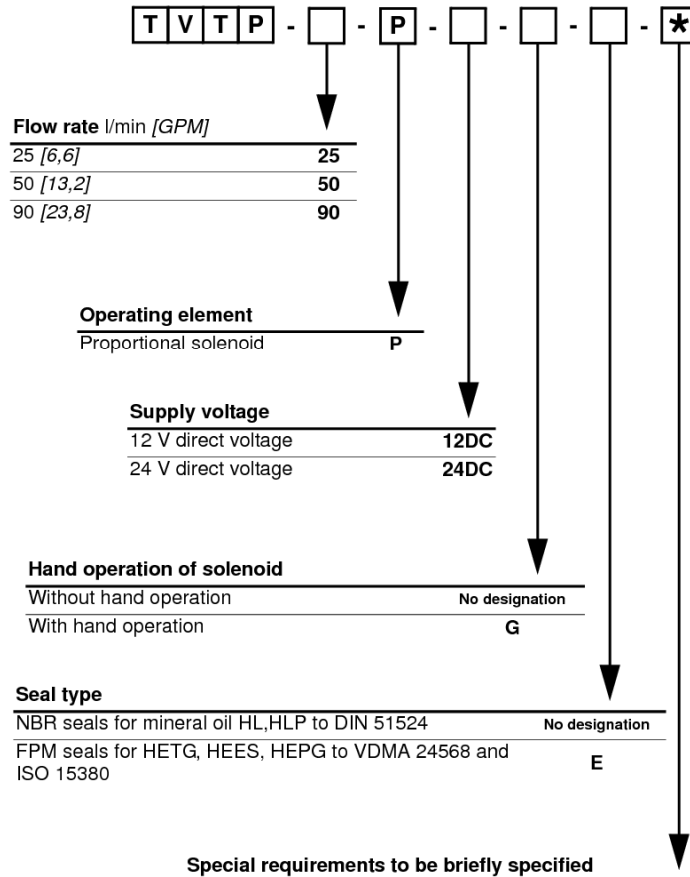

FLOW DIVIDER DTP

- NG 6, 10
- Up to 350 Bar [5,076 PSI]
- Up to 70 l/min [18,49 GPM]
- Dividing and combining of flow independent of pressure.
- Dividing and combining ratio: 50 % / 50 %
- Direct in-line mounting.
- Threaded connections to ISO 9974 (Metric), ISO 1179 (BSPP/Gas), ISO 11926 (UNF).



DTP-10, DTP-6

Operation

The flow divider DTP has two functions, dividing and combining of fluid flow. The regulator divides the fluid flow in the direction from A to B and C, and combines flows in the direction from B and C to A. The dividing / combining ratio is 50 % : 50 %, independent of pressure in respective pipeline, B or C.

The regulator consists of a housing (1), two dividing spools (2) and three weak springs (3).

Division of flow: The fluid flow in the direction from A to B and C.

The flow in chamber A is divided and flows through the orifices (5) with constant cross-section and throttles (4) into chambers B and C. The pressure drop through the orifices (5) depends on the pressure load. The increase of flow towards one of both chambers provokes increased pressure drop through the orifices. The pressure drop generates the pressure force which shifts both spools (2). Consequently, the throttles (4) are reduced, and the pressure drop of fluid through the throttles increases. The spools keep on moving until the pressure drops through the orifices (5) are balanced. Consequently, both fluid flows are balanced, too.

Combining of flows: The oil flow in the direction from B and C to A. The operation is identical as at dividing of flow. The divider combines both flows in the ratio 50% to 50%.

The principle of operation depends on the pressure drop, which again depends on the fluid flow. For this reason the divider functions properly only within the defined flow range. Limitation of maximal flow - rate of pressure drop, limitation of minimal pressure - dividing and combining accuracy

Hydraulic symbol

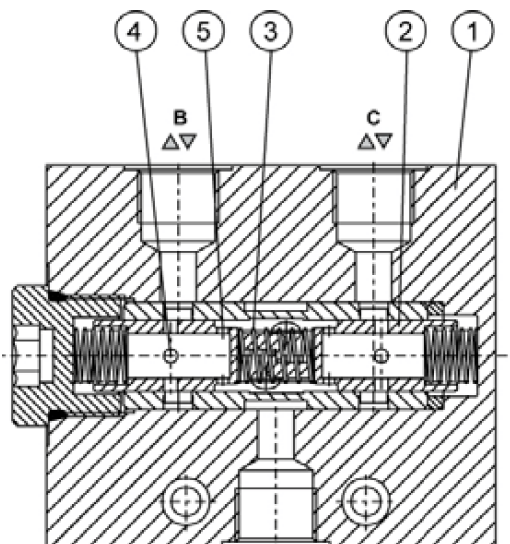
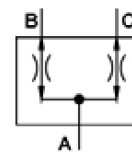

Features

Type		DTP-6-20	DTP-6-35	DTP-6-50	DTP-10-70
Min. flow rate	l/min [GPM]	8 [2,11]	12 [3,17]	16 [4,23]	35 [9,25]
Max. flow rate	l/min [GPM]	20 [5,28]	35 [9,25]	50 [13,21]	70 [18,49]
Max. pressure range	Bar [PSI]	350 [5076]			
Dividing	%	50 : 50			
Flow dividing accuracy	%	±5			
Oil temperature range	°C [°F]	-20 to +70 [-4 to +158]			
Viscosity range	mm ² /s [SUS]	15 to 380 [59 to 716]			
Filtration	NAS 1638	8			
Mass	kg [lbs]	1,7 [3,75]		2,65 [5,84]	

Dimensions

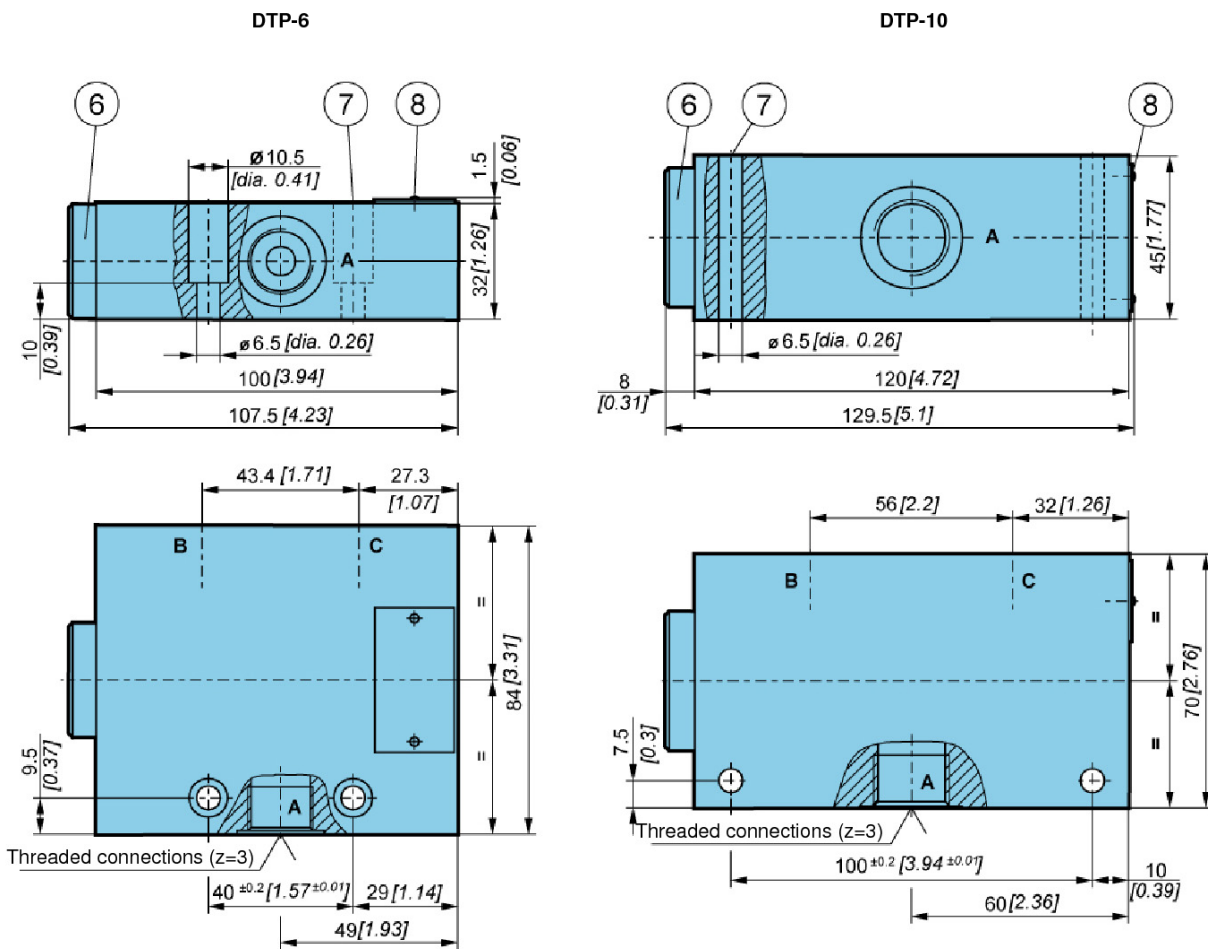

- 6. Valve cap
- 7. Two fixing holes for screws ISO 4762
DTP-6 = M6 x 20-10.9
DTP-10 = M6 x 55-10.9
Tightening torque Md = max.15 Nm
- 8. Nameplate

ΔP-Q Performance curves

Measured at 50 °C [122 °F] and viscosity of 32 mm²/s [148 SUS].

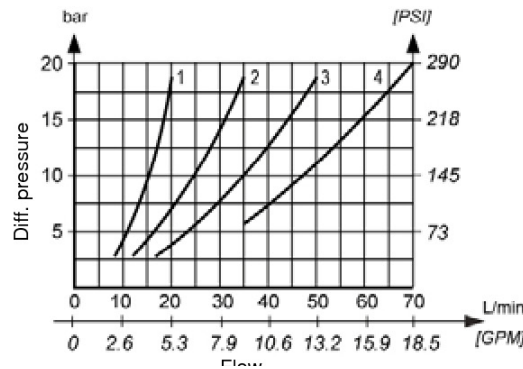

- 1. DTP-6-20
- 2. DTP-6-35
- 3. DTP-6-50
- 4. DTP-10-70

PUTTING IN SERVICE

D T P - [] - [] - [] - [] - *

Size

Size 6	6
Size 10	10

Flow rate l/min [GPM]

	8 - 20 [2,11 - 5,28]	20
DTP-6	12-35 [3,17 - 9,25]	35
	16 - 50 [4,23 - 13,21]	50
DTP-10	35 - 70 [9,25 - 18,49]	70

Threaded connection

	M 18x15	No designation
DTP-6	G 3/8	G 3/8
	3/4-16 UNF-2B	SAE 8
DTP-10	M 22x1,5	M 22
	G 1/2	G 1/2
	7/8-14 UNF-2B	SAE 10

Seal type

NBR seals for mineral oil HL,HLP to DIN 51524	No designation
FPM seals for HETG, HEES, HEPG to VDMA 24568 and ISO 15380	E

Special requirements to be briefly specified